

# SHARP®

## LC-37D90U

LIQUID CRYSTAL TELEVISION  
TÉLÉVISEUR ACL  
TELEVISOR CON PANTALLA  
DE CRISTAL LÍQUIDO

OPERATION MANUAL  
MODE D'EMPLOI  
MANUAL DE OPERACIÓN

# AQUOS

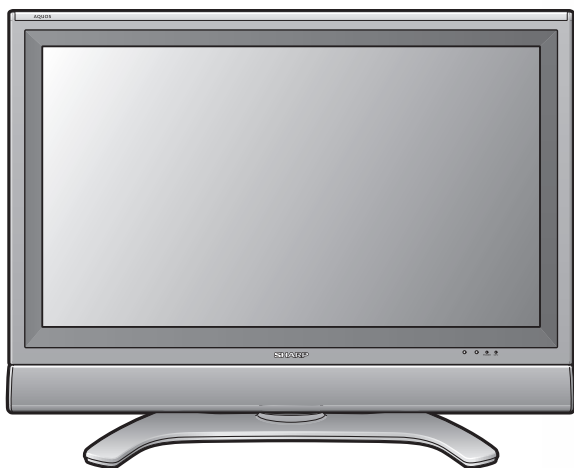

**NOM** 1245



**DOLBY**  
DIGITAL

**DTV LINK**

**HDMI**<sup>™</sup>  
HIGH-DEFINITION MULTIMEDIA INTERFACE

**HDTV**  
HIGH-DEFINITION TELEVISION

ENGLISH

FRANÇAIS

ESPAÑOL

# LC-37D90U

## LIQUID CRYSTAL TELEVISION

### ENGLISH

#### OPERATION MANUAL

- The illustrations and on-screen displays in this operation manual are for explanation purposes and may vary slightly from the actual operations.
- Menu items that are not selectable are grayed out.

#### IMPORTANT:

To aid reporting in case of loss or theft, please record the TV's model and serial numbers in the space provided. The numbers are located at the rear of the TV.

Model No.:

Serial No.:

## IMPORTANT INFORMATION

**WARNING:** TO REDUCE THE RISK OF FIRE OR ELECTRIC SHOCK, DO NOT EXPOSE THIS PRODUCT TO RAIN OR MOISTURE.



#### CAUTION

RISK OF ELECTRIC SHOCK  
DO NOT OPEN



CAUTION: TO REDUCE THE RISK OF ELECTRIC SHOCK,  
DO NOT REMOVE COVER (OR BACK).  
NO USER-SERVICEABLE PARTS INSIDE.  
REFER SERVICING TO QUALIFIED SERVICE  
PERSONNEL.



The lightning flash with arrow-head symbol, within an equilateral triangle, is intended to alert the user to the presence of uninsulated "dangerous voltage" within the product's enclosure that may be of sufficient magnitude to constitute a risk of electric shock to persons.



The exclamation point within a triangle is intended to alert the user to the presence of important operating and maintenance (servicing) instructions in the literature accompanying the product.

# IMPORTANT INFORMATION

**CAUTION:** TO PREVENT ELECTRIC SHOCK, MATCH WIDE BLADE OF PLUG TO WIDE SLOT, FULLY INSERT.

**CAUTION:**

DO NOT PLACE THIS PRODUCT ON AN UNSTABLE CART, STAND, TRIPOD, BRACKET, OR TABLE. THE PRODUCT MAY FALL CAUSING SERIOUS PERSONAL INJURY AND SERIOUS DAMAGE TO THE PRODUCT. USE ONLY WITH A CART, STAND, TRIPOD, BRACKET, OR TABLE RECOMMENDED BY THE MANUFACTURER OR SOLD WITH THE PRODUCT. FOLLOW THE MANUFACTURER'S INSTRUCTIONS WHEN INSTALLING THE PRODUCT AND USE MOUNTING ACCESSORIES RECOMMENDED BY THE MANUFACTURER. A PRODUCT AND CART COMBINATION SHOULD BE MOVED WITH CARE. QUICK STOPS, EXCESSIVE FORCE, AND UNEVEN SURFACES MAY CAUSE THE PRODUCT AND CART COMBINATION TO OVERTURN.



**WARNING:** FCC Regulations state that any unauthorized changes or modifications to this equipment not expressly approved by the manufacturer could void the user's authority to operate this equipment.

**CAUTION:**

This product satisfies FCC regulations when shielded cables and connectors are used to connect the unit to other equipment. To prevent electromagnetic interference with electric appliances such as radios and televisions, use shielded cables and connectors for connections.

**DECLARATION OF CONFORMITY:**

SHARP LIQUID CRYSTAL TELEVISION, MODEL LC-37D90U

This device complies with Part 15 of the FCC Rules. Operation is subject to the following two conditions:

(1) This device may not cause harmful interference, and (2) this device must accept any interference received, including interference that may cause undesired operation.

RESPONSIBLE PARTY:

SHARP ELECTRONICS CORPORATION

Sharp Plaza, Mahwah, New Jersey 07430-2135

TEL: 1-800-BE-SHARP

For Business Customers: URL <http://www.sharppusa.com>

**INFORMATION:**

This equipment has been tested and found to comply with the limits for a Class B digital device, pursuant to Part 15 of the FCC Rules. These limits are designed to provide reasonable protection against harmful interference in a residential installation. This equipment generates, uses and can radiate radio frequency energy and, if not installed and used in accordance with the instructions, may cause harmful interference to radio communications. However, there is no guarantee that interference will not occur in a particular installation. If this equipment does cause harmful interference to radio or television reception, which can be determined by turning the equipment off and on, the user is encouraged to try to correct the interference by one or more of the following measures:

- Reorient or relocate the receiving antenna.
- Increase the separation between the equipment and receiver.
- Connect the equipment into an outlet on a circuit different from that to which the receiver is connected.
- Consult the dealer or an experienced radio/TV technician for help.

“Note to CATV system installer: This reminder is provided to call the CATV system installer's attention to Article 820-40 of the National Electrical Code that provides guidelines for proper grounding and, in particular, specifies that the cable ground shall be connected to the grounding system of the building, as close to the point of cable entry as practical.”

This product utilizes tin-lead solder, and fluorescent lamp containing a small amount of mercury. Disposal of these materials may be regulated due to environmental considerations. For disposal or recycling information, please contact your local authorities or the Electronic Industries Alliance: [www.eia.org](http://www.eia.org)

## Trademarks

- Manufactured under license from Dolby Laboratories. “Dolby” and the double-D symbol are trademarks of Dolby Laboratories.

- “HDMI, the HDMI logo and High-Definition Multimedia Interface are trademarks or registered trademarks of HDMI Licensing LLC.”

# DEAR SHARP CUSTOMER

Thank you for your purchase of the Sharp Liquid Crystal Television. To ensure safety and many years of trouble-free operation of your product, please read the Important Safety Instructions carefully before using this product.

## IMPORTANT SAFETY INSTRUCTIONS

Electricity is used to perform many useful functions, but it can also cause personal injuries and property damage if improperly handled. This product has been engineered and manufactured with the highest priority on safety. However, improper use can result in electric shock and/or fire. In order to prevent potential danger, please observe the following instructions when installing, operating and cleaning the product. To ensure your safety and prolong the service life of your Liquid Crystal Television, please read the following precautions carefully before using the product.

- 1) Read these instructions.
- 2) Keep these instructions.
- 3) Heed all warnings.
- 4) Follow all instructions.
- 5) Do not use this apparatus near water.
- 6) Clean only with dry cloth.
- 7) Do not block any ventilation openings. Install in accordance with the manufacturer's instructions.
- 8) Do not install near any heat sources such as radiators, heat registers, stoves, or other apparatus (including amplifiers) that produce heat.
- 9) Do not defeat the safety purpose of the polarized or grounding-type plug. A polarized plug has two blades with one wider than the other. A grounding type plug has two blades and a third grounding prong. The wide blade or the third prong are provided for your safety. If the provided plug does not fit into your outlet, consult an electrician for replacement of the obsolete outlet.
- 10) Protect the power cord from being walked on or pinched particularly at plugs, convenience receptacles, and the point where they exit from the apparatus.
- 11) Only use attachments/accessories specified by the manufacturer.
- 12) Use only with the cart, stand, tripod, bracket, or table specified by the manufacturer, or sold with the apparatus. When a cart is used, use caution when moving the cart/apparatus combination to avoid injury from tip-over.
- 13) Unplug this apparatus during lightning storms or when unused for long periods of time.
- 14) Refer all servicing to qualified service personnel. Servicing is required when the apparatus has been damaged in any way, such as power-supply cord or plug is damaged, liquid has been spilled or objects have fallen into the apparatus, the apparatus has been exposed to rain or moisture, does not operate normally, or has been dropped.



### Additional Safety Information

- 15) Power Sources—This product should be operated only from the type of power source indicated on the marking label. If you are not sure of the type of power supply to your home, consult your product dealer or local power company. For products intended to operate from battery power, or other sources, refer to the operating instructions.
- 16) Overloading—Do not overload wall outlets, extension cords, or integral convenience receptacles as this can result in a risk of fire or electric shock.
- 17) Object and Liquid Entry—Never push objects of any kind into this product through openings as they may touch dangerous voltage points or short-out parts that could result in a fire or electric shock. Never spill liquid of any kind on the product.
- 18) Damage Requiring Service—Unplug this product from the wall outlet and refer servicing to qualified service personnel under the following conditions:
  - a) When the AC cord or plug is damaged,
  - b) If liquid has been spilled, or objects have fallen into the product,
  - c) If the product has been exposed to rain or water,
  - d) If the product does not operate normally by following the operating instructions.  
Adjust only those controls that are covered by the operating instructions as an improper adjustment of other controls may result in damage and will often require extensive work by a qualified technician to restore the product to its normal operation,
  - e) If the product has been dropped or damaged in any way, and
  - f) When the product exhibits a distinct change in performance - this indicates a need for service.
- 19) Replacement Parts—When replacement parts are required, be sure the service technician has used replacement parts specified by the manufacturer or have the same characteristics as the original part. Unauthorized substitutions may result in fire, electric shock, or other hazards.
- 20) Safety Check—Upon completion of any service or repairs to this product, ask the service technician to perform safety checks to determine that the product is in proper operating condition.
- 21) Wall or ceiling mounting—When mounting the product on a wall or ceiling, be sure to install the product according to the method recommended by the manufacturer.

# IMPORTANT SAFETY INSTRUCTIONS

- **Water and Moisture** — Do not use this product near water - for example, near a bath tub, wash bowl, kitchen sink, or laundry tub; in a wet basement; or near a swimming pool; and the like.



- **Stand** — Do not place the product on an unstable cart, stand, tripod or table. Placing the product on an unstable base can cause the product to fall, resulting in serious personal injuries as well as damage to the product. Use only a cart, stand, tripod, bracket or table recommended by the manufacturer or sold with the product. When mounting the product on a wall, be sure to follow the manufacturer's instructions. Use only the mounting hardware recommended by the manufacturer.



- **Selecting the location** — Select a place with no direct sunlight and good ventilation.

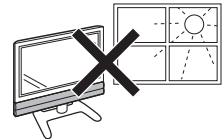

- **Ventilation** — The vents and other openings in the cabinet are designed for ventilation. Do not cover or block these vents and openings since insufficient ventilation can cause overheating and/or shorten the life of the product. Do not place the product on a bed, sofa, rug or other similar surface, since they can block ventilation openings. This product is not designed for built-in installation; do not place the product in an enclosed place such as a bookcase or rack, unless proper ventilation is provided or the manufacturer's instructions are followed.

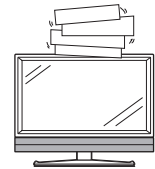

- **The Liquid Crystal panel** used in this product is made of glass. Therefore, it can break when the product is dropped or applied with impact. Be careful not to be injured by broken glass pieces in case the panel breaks.

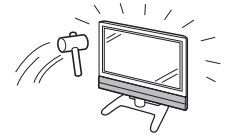

- **Heat** — The product should be situated away from heat sources such as radiators, heat registers, stoves, or other products (including amplifiers) that produce heat.

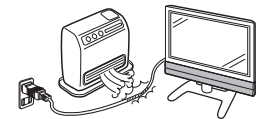

- The Liquid Crystal panel is a very high technology product with 6,220,800 thin film transistors, giving you fine picture details. Occasionally, a few non-active pixels may appear on the screen as a fixed point of blue, green or red. Please note that this does not affect the performance of your product.

## Precautions when transporting the TV

- When transporting the TV, never carry it by holding onto the speakers. Be sure to always carry the TV by two people holding it with two hands — one hand on each side of the TV.

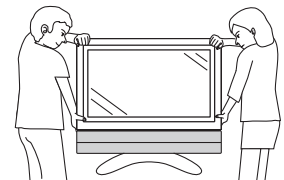

- **Lightning** — For added protection for this television equipment during a lightning storm, or when it is left unattended and unused for long periods of time, unplug it from the wall outlet and disconnect the antenna. This will prevent damage to the equipment due to lightning and power-line surges.

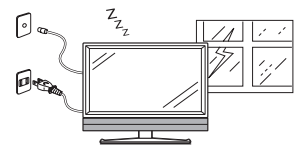

- **Power Lines** — An outside antenna system should not be located in the vicinity of overhead power lines or other electric light or power circuits, or where it can fall into such power lines or circuits. When installing an outside antenna system, extreme care should be taken to keep from touching such power lines or circuits as contact with them might be fatal.

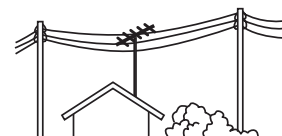

# IMPORTANT SAFETY INSTRUCTIONS

- Outdoor Antenna Grounding — If an outside antenna is connected to the television equipment, be sure the antenna system is grounded so as to provide some protection against voltage surges and built-up static charges. Article 810 of the National Electrical Code, ANSI/NFPA 70, provides information with regard to proper grounding of the mast and supporting structure, grounding of the lead-in wire to an antenna discharge unit, size of grounding conductors, location of antenna-discharge unit, connection to grounding electrodes, and requirements for the grounding electrode.

EXAMPLE OF ANTENNA GROUNDING AS PER NATIONAL ELECTRICAL CODE, ANSI/NFPA 70

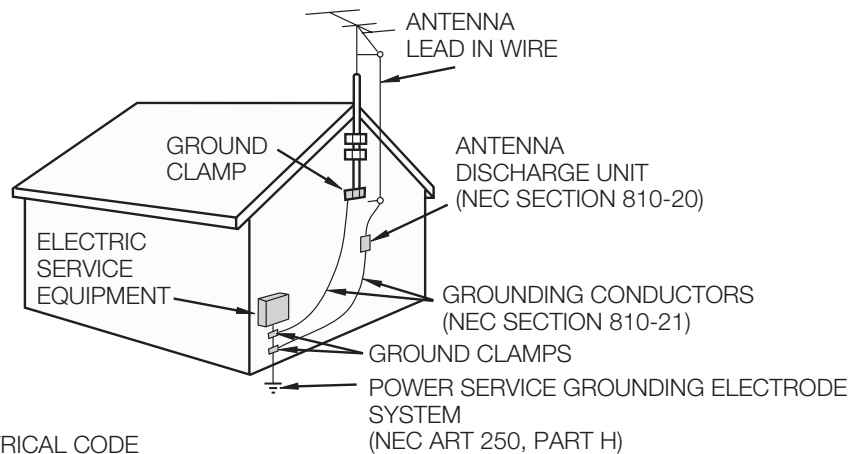

- To prevent fire, never place any type of candle or flames on the top or near the TV set.

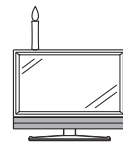

- To prevent fire or shock hazard, do not expose this product to dripping or splashing. No objects filled with liquids, such as vases, should be placed on the product.



- To prevent fire or shock hazard, do not place the AC cord under the TV set or other heavy items.

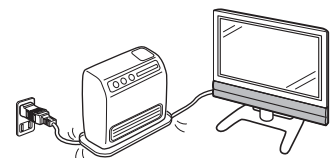



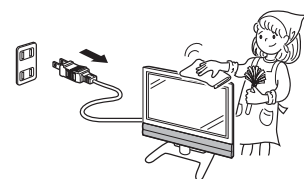

- Turn off the main power and unplug the AC cord from the wall outlet before handling.
- Use a soft cloth and gently wipe the surface of the display panel. Using a hard cloth may scratch the panel surface.
- Use a soft damp cloth to gently wipe the panel when it is really dirty. (It may scratch the panel surface when wiped strongly.)
- If the panel is dusty, use an anti-static brush, which is commercially available, to clean it.
- To protect the panel, do not use a dirty cloth, liquid cleaners or chemical cloth to clean it, such materials may damage the panel surface.
- To clean the outer cabinet, use the same method. Do not use liquid or aerosol cleaners.

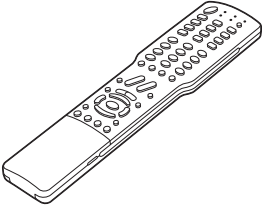

- Do not display a still picture for a long time, as this could cause an afterimage to remain.

# Supplied accessories

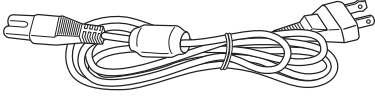
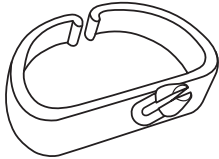
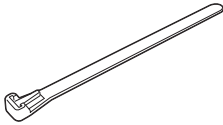
Make sure the following accessories are provided with the product.

Remote control unit (× 1)	“AAA” size battery (× 2)	AC cord (× 1)
 <p data-bbox="316 678 397 707">Page 8</p>	 <p data-bbox="756 678 837 707">Page 8</p>	 <p data-bbox="1198 678 1279 707">Page 7</p>
Cable Clamp (× 1)	Cable tie (× 1)	Operation manual (× 1)
 <p data-bbox="316 1155 397 1184">Page 7</p>	 <p data-bbox="756 1155 837 1184">Page 7</p>	

**NOTE**

- Always use the AC cord supplied with the TV.

# QUICK REFERENCE

## STOP! To safely remove the AQUOS television from the box

- It's best to use 2 people to remove the AQUOS television for stability.
- Lift onto installation location as the diagram illustrates.

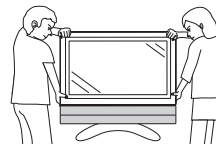

## Ventilation & Cleaning Tips

Keep your AQUOS television in a well ventilated area and make sure not to place it by a heat source or use near water. The AQUOS television is designed for AC use only and should be used with supplied AC cord.

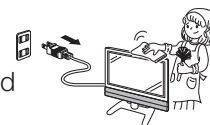

Clean the screen by spraying a soft lint free cloth with water to lightly moisten. Gently wipe and avoid pressing on the screen. To clean the outer cabinet, use the same method. Do not use liquid or aerosol cleaners.



The screen is glass and can be scratched or broken when dropped or impacted.

## QUICK INSTALLATION TIPS

1. Attach your antenna to the back of the AQUOS television. (See page 13.)
2. Connect the AC plug for the AQUOS television into the AC outlet.
3. Bundle the cords properly with a cable clamp and cable tie.
4. How to turn on the AQUOS television for the first time.
  - A) Press **POWER** on AQUOS television.

2. Connect the AC plug for the AQUOS television into the AC outlet.

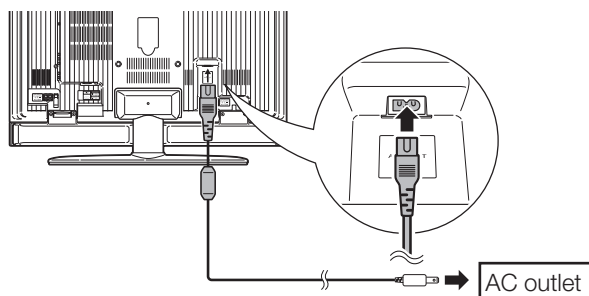

- Place the TV close to the AC outlet, and keep the power plug within reach.

### NOTE

- **TO PREVENT RISK OF ELECTRIC SHOCK, DO NOT TOUCH UN-INSULATED PARTS OF ANY CABLES WITH THE AC CORD CONNECTED.**
3. Bundle the cords properly with a cable clamp and cable tie.

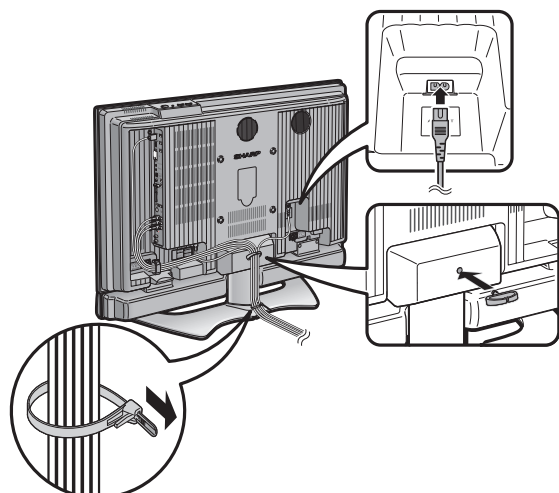

- A) Press **POWER** on AQUOS television.

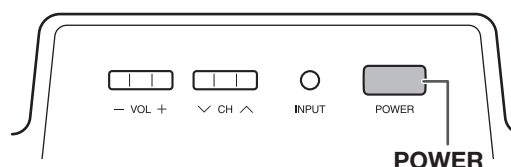

- B) POWER indicator on the front of the AQUOS television lights BLUE.

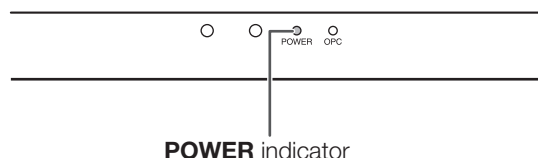

### NOTE

- The TV can be swiveled 10 degrees right and left with TV stand attached.
- You cannot tilt the screen vertically.



## QUICK REFERENCE

If the remote control fails to operate TV functions, replace the batteries in the remote control unit.

**1** Open the battery cover.

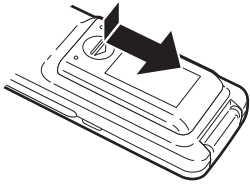

**2** Insert two "AAA" size batteries (supplied with the product).

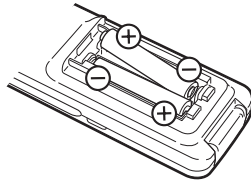

**3** Close the battery cover.

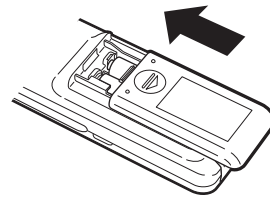

- Place the batteries with their terminals corresponding to the (+) and (-) indications in the battery compartment.

### NOTE

Improper use of batteries can result in chemical leakage or explosion. Be sure to follow the instructions below.

- Do not mix batteries of different types. Different types of batteries have different characteristics.
- Do not mix old and new batteries. Mixing old and new batteries can shorten the life of new batteries or cause chemical leakage in old batteries.
- Remove batteries as soon as they are worn out. Chemicals that leak from batteries that come in contact with skin can cause a rash. If you find any chemical leakage, wipe thoroughly with a cloth.
- The batteries supplied with this product may have a shorter life expectancy due to storage conditions.
- If you will not be using the remote control unit for an extended period of time, remove batteries from it.

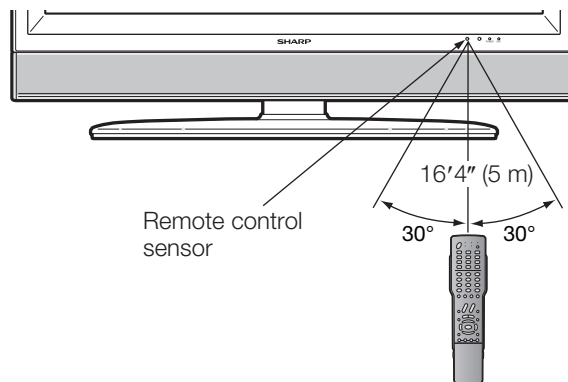

### IMPORTANT:

The POWER indicator on the AQUOS television should light BLUE indicating you have power to the AQUOS television.

If the POWER indicator on the AQUOS television still does not light up, press **TV POWER** on the remote control to turn the power on.

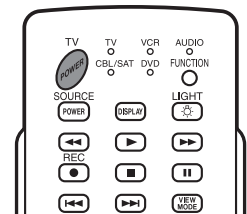

### IMPORTANT:

IF THE UNIT DOES NOT POWER ON - UNPLUG THE AQUOS TELEVISION FROM THE OUTLET AND REPEAT THE INSTALLATION STEPS.

IF YOU STILL ENCOUNTER NO POWER, PLEASE CONTACT US AT 1-800-BE-SHARP.

Please refer to the BASIC ADJUSTMENT SETTINGS SECTION for EZ Setup and basic channel setup functions and USING EXTERNAL EQUIPMENT SECTION for other device connections (DVD, VCR, AUDIO, etc) in your AQUOS operation manual.

# Contents

<b>IMPORTANT INFORMATION</b> .....	<b>1</b>	Setting the Recording Mode (i.LINK).....	35
<b>Trademarks</b> .....	<b>2</b>	Setting the Standby Mode (i.LINK).....	35
<b>DEAR SHARP CUSTOMER</b> .....	<b>3</b>	Selecting an i.LINK device .....	36
<b>IMPORTANT SAFETY INSTRUCTIONS</b> .....	<b>3</b>	Disabling the TV's operation of an i.LINK device .....	36
<b>Supplied accessories</b> .....	<b>6</b>	Deleting registered i.LINK device .....	36
<b>QUICK REFERENCE</b> .....	<b>7</b>	Controlling an i.LINK device.....	37
<b>Contents</b> .....	<b>9</b>	Automatic input switching to i.LINK .....	40
<b>Part names</b> .....	<b>10</b>	Recording digital programs with a D-VHS deck (i.LINK) .....	40
TV (Front) .....	10	Recording digital programs with AV-HDD recorder/Blu-ray Disc recorder .....	41
TV (Rear) .....	11	Playing back using REC LIST (i.LINK) .....	41
Remote control unit .....	12	Capture and playback video with an HDV camcorder .....	42
<b>Preparation</b> .....	<b>13</b>	DTVLink .....	43
Using the remote control unit.....	13	Remote Control Pass-through.....	43
Cautions regarding the remote control unit.....	13	OSD Switch .....	43
Antennas.....	13	<b>Useful adjustment settings</b> .....	<b>44</b>
<b>Watching TV</b> .....	<b>14</b>	Input Skip.....	44
Turning on the power .....	14	Standby Mode.....	44
Turning off the power .....	14	Language setting.....	44
Initial setup .....	15	Image position (AV input mode only).....	44
Simple button operations for changing channels .....	16	Auto Sync. adjustment (for Analog PC input mode only) .....	45
Simple button operations for changing volume/sound .....	17	Fine Sync. adjustment .....	45
Setting MTS/SAP stereo mode.....	18	Reset .....	46
Setting Digital broadcasting audio mode .....	18	Input Select .....	47
<b>Basic adjustment settings</b> .....	<b>19</b>	Input Label .....	48
Menu operation buttons .....	19	Picture Flip .....	48
On-Screen Display .....	19	View Mode for 4:3 Programs .....	49
Menu items for TV/INPUT 1/INPUT 2.....	20	View Mode for HD Programs .....	49
Menu items for HDMI/DVI.....	20	View Mode (for PC input mode).....	50
EZ Setup .....	21	AV MODE.....	51
Channel Setup .....	21	Input Signal (for PC input mode) .....	51
Antenna Setup-DIGITAL.....	22	Digital Noise Reduction .....	52
Favorite channel setting.....	23	Audio Only.....	52
Picture adjustments.....	24	Output Select .....	52
OPC setting.....	24	Quick Shoot .....	52
Advanced picture adjustments .....	25	Color System .....	53
Color Temperature .....	25	Program Title Display.....	53
Black.....	25	Sleep Timer .....	53
3D-Y/C.....	25	Closed Captions and Digital Closed Captions.....	54
Monochrome.....	25	Caption Setup.....	55
Film Mode (3:2 pull-down) .....	25	Secret number setting for parental control (AV input mode only) .....	56
Range of OPC .....	25	Parental control (setting V-CHIP level).....	58
Sound adjustment .....	26	How to temporarily release the V-CHIP BLOCK .....	61
Surround .....	26	Reactivating the temporarily released V-CHIP BLOCK.....	61
Power Control .....	27	<b>Other viewing options</b> .....	<b>62</b>
Digital Setup.....	28	Viewing a list of channels.....	62
Audio Setup .....	28	Viewing information of the program .....	62
<b>Using external equipment</b> .....	<b>29</b>	Freezing images .....	63
Displaying an external equipment image .....	29	Presetting remote control function .....	63
Connecting a DVD player or a Digital TV STB (Air or Cable) .....	30	<b>Appendix</b> .....	<b>67</b>
Connecting HDMI equipment .....	31	Removing the stand .....	67
Displaying an image from HDMI equipment .....	31	Setting the TV on the wall.....	67
Connecting a PC .....	32	Removing the speakers .....	68
Connecting a VCR, game console or camcorder .....	32	Troubleshooting .....	69
Using Digital Audio Output.....	32	Troubleshooting-Digital broadcasting .....	70
Connecting D-VHS decks/AV-HDD recorder/ Blu-ray Disc recorder/Digital STB/Digital TV/HDV camcorder (i.LINK connection) .....	33	PC compatibility chart .....	70
About i.LINK.....	33	RS-232C port specifications.....	71
i.LINK connection .....	33	Specifications .....	73
Connecting two or more i.LINK devices.....	33	Optional accessory.....	73
Setting the input source (i.LINK) .....	34	<b>Dimensional drawings</b> .....	<b>74</b>

# Part names

## TV (Front)

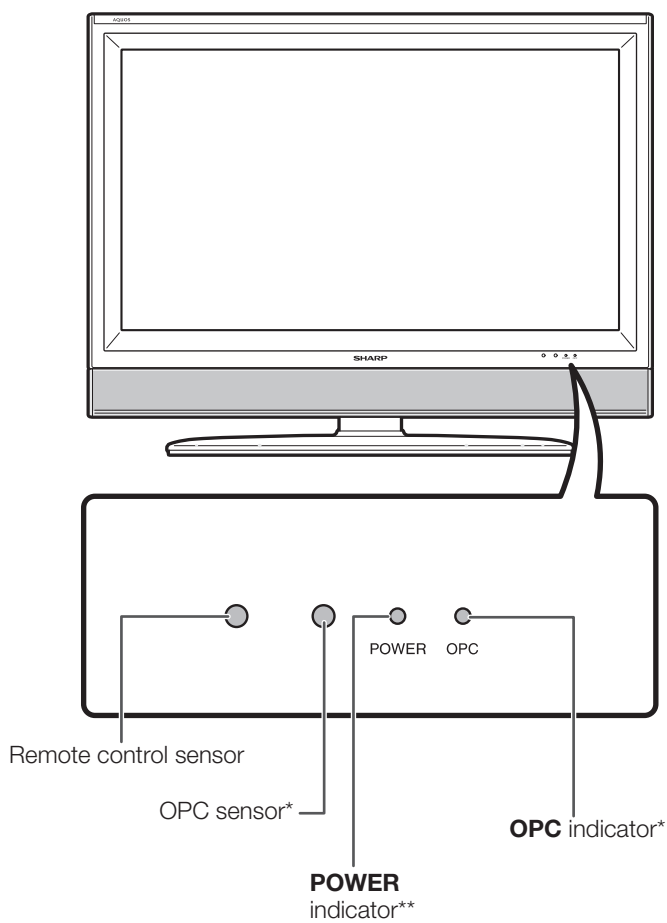
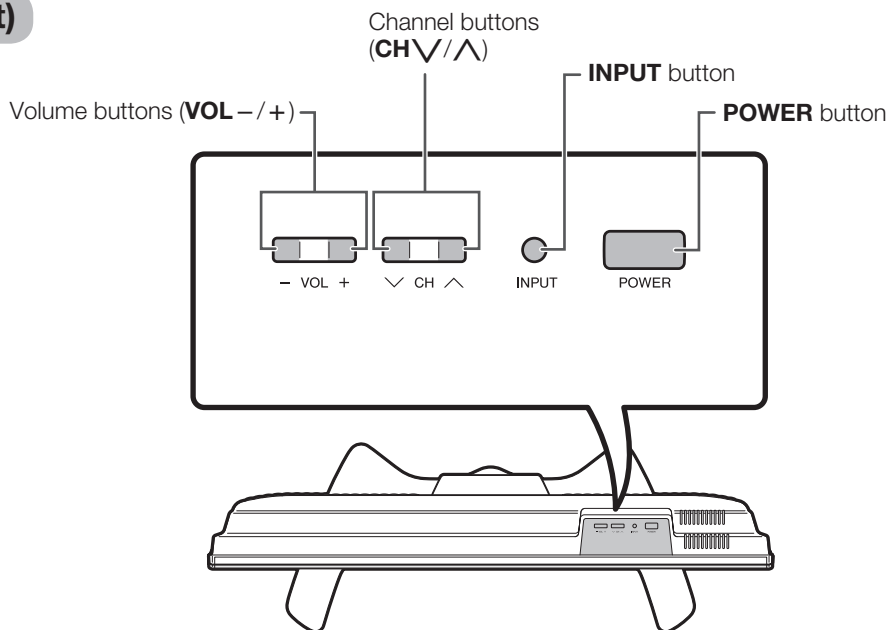

### NOTE

\*OPC: Optical Picture Control (See page 24.)

\*\*See page 14 for TV status indicator.

Part names

TV (Rear)

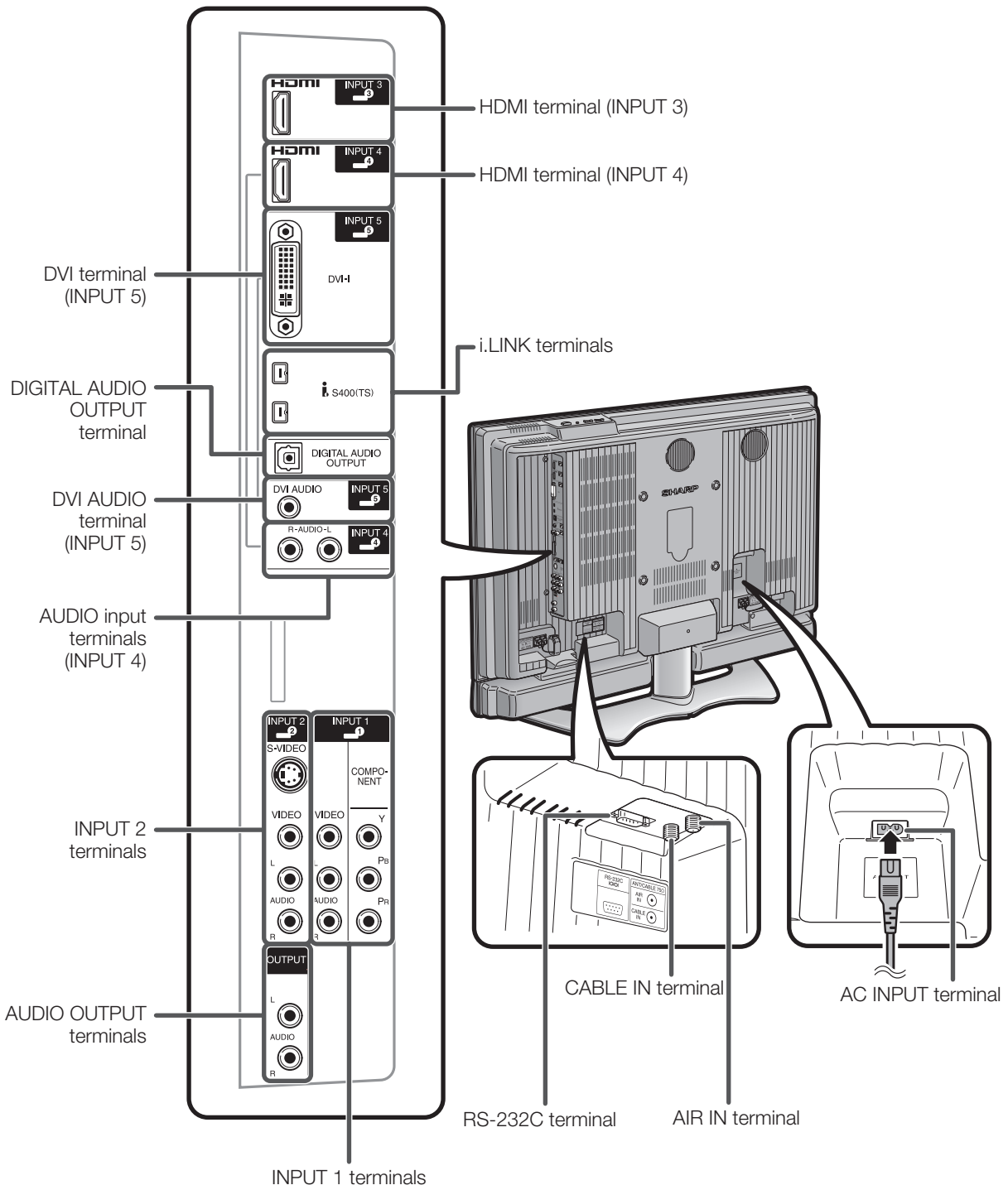

Remote control unit

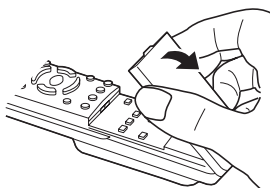
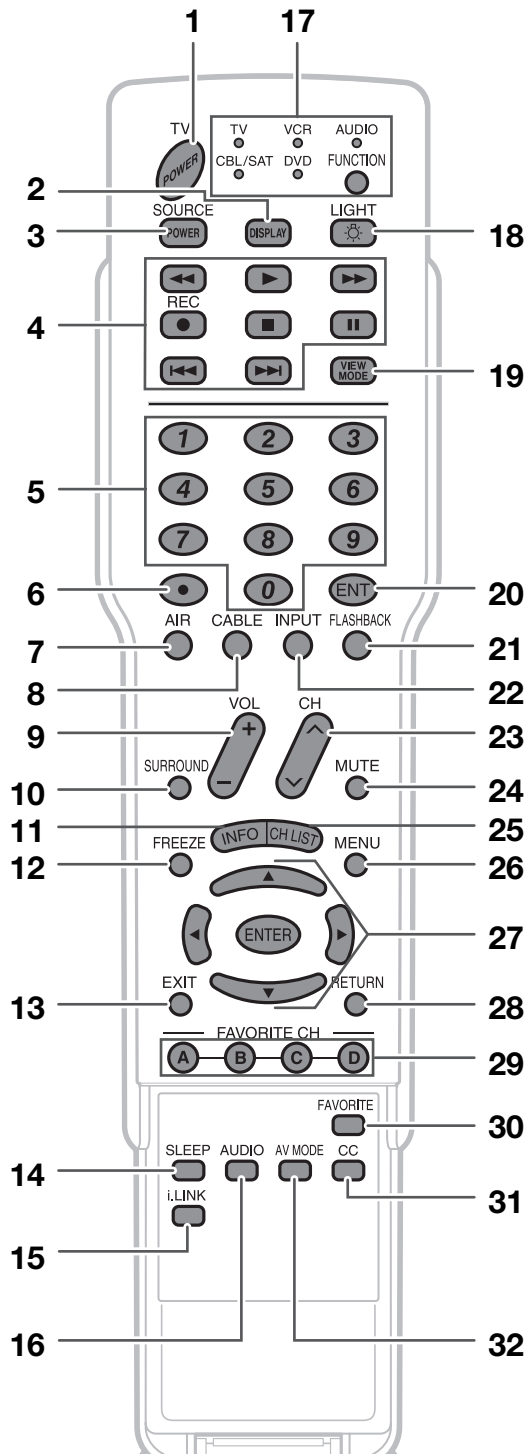

**NOTE**

• When using the remote control unit, point it at the TV.

- 1 **TV POWER:** Switches the TV power on or enters standby mode. (See page 14.)
- 2 **DISPLAY:** Displays the channel information.
- 3 **SOURCE POWER:** Turns the power of the external equipment on and off.
- 4 **External equipment operational buttons:** Operates the external equipment.
- 5 **0 – 9:** Sets the channel. (See page 16.)
- 6 **• (DOT):** (See pages 16 and 65.)
- 7 **AIR:** Receives air signal.
- 8 **CABLE:** Receives cable signal.
- 9 **VOL +/-:** Sets the volume. (See page 17.)
- 10 **SURROUND:** Selects Surround settings. (See page 17.)
- 11 **INFO:** Displays the program information screen. (See page 62.)
- 12 **FREEZE:** Sets the still image. Press again to return to normal screen. (See page 63.)
- 13 **EXIT:** Turns off the menu screen.
- 14 **SLEEP:** Sets the sleep timer. (See page 53.)
- 15 **i.LINK:** Displays the i.LINK control panel. (See page 36.)
- 16 **AUDIO:** Selects the MTS/SAP or the audio mode during multi-channel audio broadcasts. (See page 18.)
- 17 **FUNCTION:** Switches the remote control for TV, CBL/SAT, VCR, DVD and AUDIO mode. Indicator lights up for the current mode. (See pages 63 to 66 for details.)  
 \* To enter the code registration mode, you need to press **FUNCTION** and **DISPLAY** at the same time.
- 18 **LIGHT** : When pressed all buttons on the remote control unit will light. The lighting will turn off if no operations are performed within about 5 seconds. This button is used for performing operations in low-light situations.
- 19 **VIEW MODE:** Selects the screen size. (See page 49.)
- 20 **ENT:** Jumps to a channel after selecting with the **0–9** buttons.
- 21 **FLASHBACK:** Returns to the previous channel or external input mode. (See page 16.)
- 22 **INPUT:** Selects a TV input source. (TV, INPUT 1, INPUT 2, INPUT 3, INPUT 4, INPUT 5, i.LINK) (See pages 29 and 47.)
- 23 **CH** : Selects the channel. (See page 16.)
- 24 **MUTE:** Mutes the sound. (See page 17.)
- 25 **CH LIST:** Displays the channel list screen. (See page 62.)
- 26 **MENU:** Displays the menu screen.
- 27 **▲/▼/◀/▶/ENTER:** Selects a desired item on the screen.
- 28 **RETURN:** Returns to the previous menu screen.
- 29 **FAVORITE CH**  
**A, B, C, D:** Selects four preset favorite channels in four different categories. (See page 23 for details.)  
 While watching, you can toggle the selected channels by pressing A, B, C and D
- 30 **FAVORITE:** Registers favorite channels. (See page 23.)
- 31 **CC:** Displays captions from a closed-caption source. (See page 54.)
- 32 **AV MODE:** Selects an audio or video setting. (AV mode: STANDARD, MOVIE, GAME, USER, DYNAMIC (Fixed), DYNAMIC. PC mode: STANDARD, MOVIE, GAME, USER, DYNAMIC (Fixed), DYNAMIC, PC.) (See page 51.)

# Preparation

## Using the remote control unit

Use the remote control unit by pointing it towards the remote control sensor on the TV. Objects between the remote control unit and the remote control sensor may prevent proper operation.

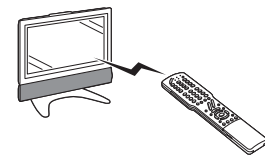

## Cautions regarding the remote control unit

- Do not expose the remote control unit to shock. In addition, do not expose the remote control unit to liquids, and do not place in an area with high humidity.
- Do not install or place the remote control unit under direct sunlight. The heat may cause deformation of the remote control unit.
- The remote control unit may not work properly if the remote control sensor on the TV is under direct sunlight or strong lighting. In such cases, change the angle of the lighting or the TV, or operate the remote control unit closer to the remote control sensor.

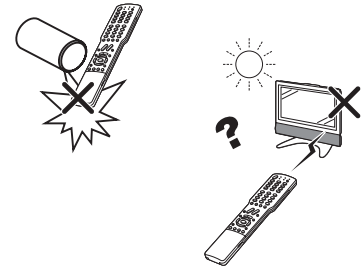

## Antennas

To enjoy a clearer picture, use an outdoor antenna. The following is a brief explanation of the types of connections that are used for a coaxial cable. If your outdoor antenna uses a 75-ohm coaxial cable with an F-type connector, plug it into the antenna terminal at the rear of the TV set.

1. A 75-ohm system is generally a round cable with F-type connector that can easily be attached to a terminal without tools (Commercially available).

F-type connector



2. A 300-ohm system is a flat "twin-lead" cable that can be attached to a 75-ohm terminal through a 300/75-ohm adapter (Commercially available).

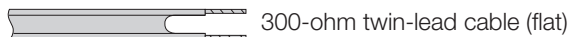

## NOTICE F-type connector should be finger-tightened only.

When connecting the RF cable to the TV set, do not tighten F-type connector with tools. If tools are used, it may cause damage to your TV set. (The breaking of internal circuit, etc.)

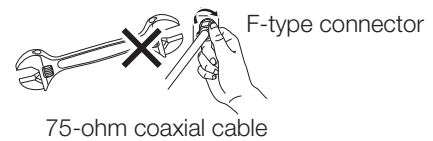

## Connecting Antenna Cable

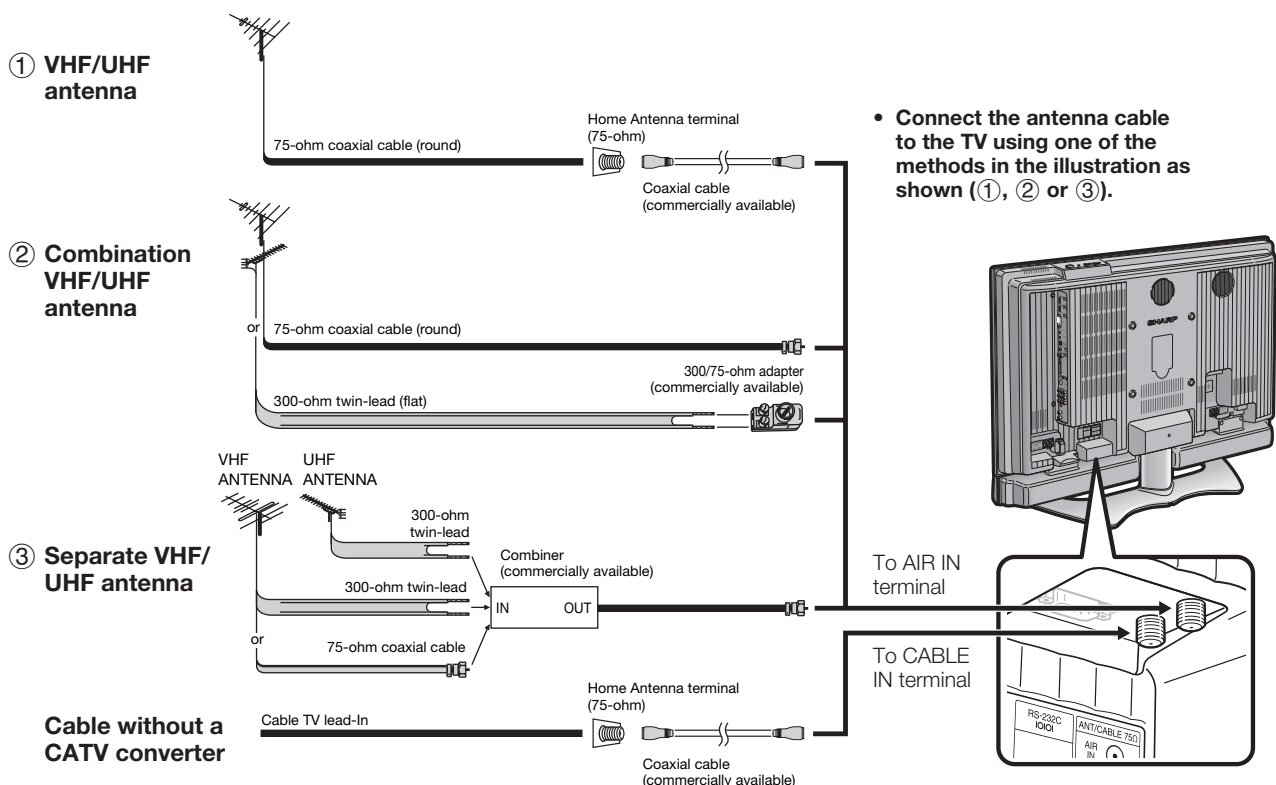

# Watching TV

Simple operations for watching a TV program

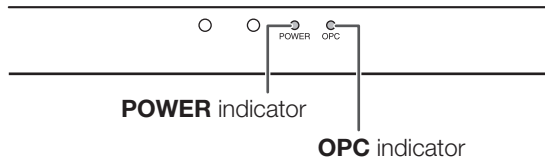
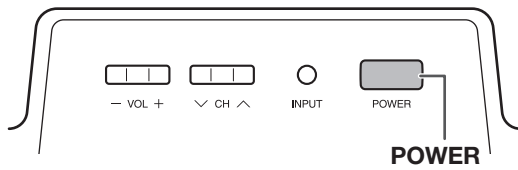

TV POWER (On/Standby)

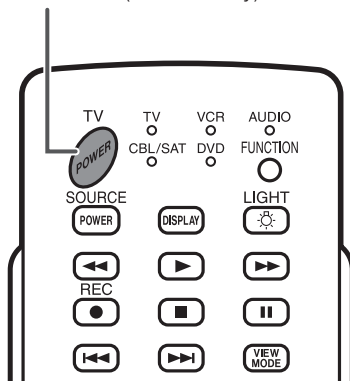

TV status indicator (POWER)

ON	Lighting (Blue)
OFF/Standby	Lights off

TV status indicator (OPC)

"Off" is selected in OPC setting	Lights off
"On" or "On: Display" is selected in OPC setting	Lighting (Green)

- See page 24 for details.

## Turning on the power

Press **POWER** on the TV, or **TV POWER** on the remote control.

- POWER indicator (Blue): The TV is on. (After a few seconds, a window appears with sound.)

### NOTE

- The initial setup starts when the TV powers on for the first time. If the TV has been turned on before, the EZ Setup will not be invoked. See page 21 for performing EZ Setup from the Setup menu.

## Turning off the power

Press **POWER** on the TV, or **TV POWER** on the remote control.

- The TV enters standby mode and the image on the screen disappears.
- The POWER indicator on the TV gradually turns off.

### NOTE

- If you are not going to use this TV for a long period of time, be sure to remove the AC cord from the power outlet.
- Weak electric power is still consumed even when **POWER** is turned off.

## Watching TV

### Initial setup

When you turn on the TV for the first time, it will automatically memorize the broadcasting channels where you live. Perform the following steps before you press **TV POWER** on the remote control unit.

1. Insert the batteries into the remote control unit. (See page 8.)
2. Connect the antenna cable to the TV. (See page 13.)
3. Plug in the AC cord to the AC outlet. (See page 7.)

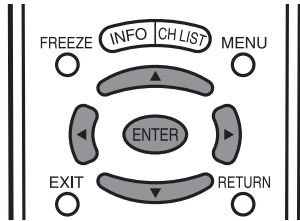

### Language setting

Select from among 3 languages: English, French and Spanish.

1

Press ▲/▼ to select the desired language listed on the screen, and then press **ENTER**.

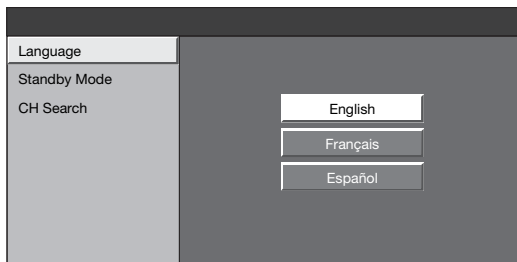

2

### Standby Mode setting

Select the standby setting. (See page 44.)

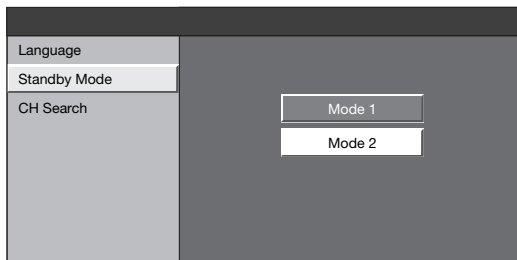

Mode 1: Starting TV is quick from standby.

Mode 2: Power consumption is small at the standby.

### Channel search

Channel auto search makes the TV look for all channels viewable in the set area.

3

Press ◀/▶ to select “Yes” or “No” for AIR Analog & Digital, then press ▼ to move down.

Press ◀/▶ to select “Yes” or “No” for CABLE Analog, then press ▼ to move down.

Press ◀/▶ to select “Yes” or “No” for CABLE Analog & Digital, then press ▼ to move down.

Select “Search Start”, and then press **ENTER**.

- If you are only receiving an analog signal through the cable, select “Yes” for CABLE Analog. If you are receiving both an analog signal and a digital signal through the cable, select “Yes” for CABLE Analog & Digital.

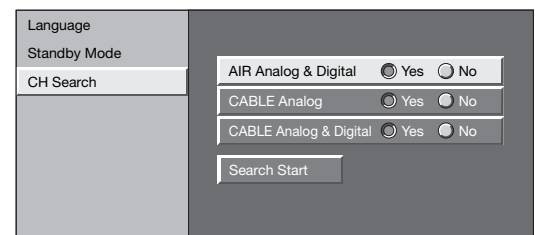

### Example

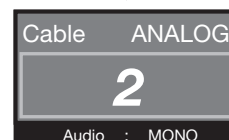

### NOTE

- If no channel is found, confirm the type of connection made with your TV and try EZ Setup again. (See page 21.)



## Simple button operations for changing channels

You can change channels in several ways by pressing **AIR** or **CABLE** to select the antenna and then following one of the methods below.

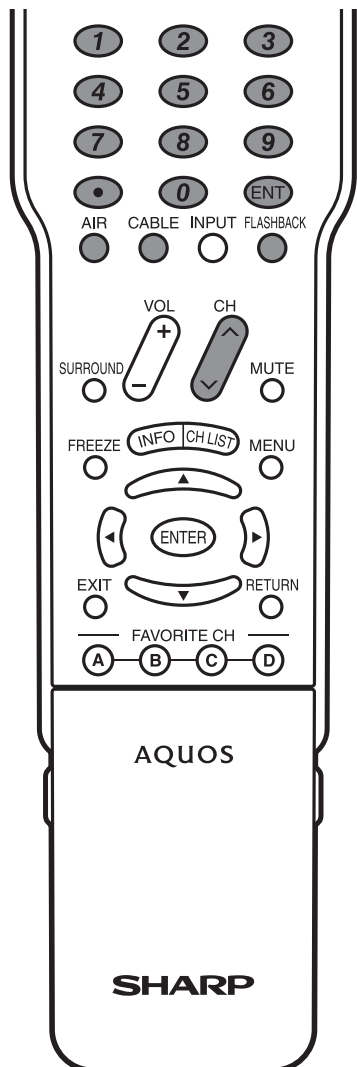

### Method 1

Using **CH**  $\wedge/\vee$  on the remote control unit or on the TV.

### Method 2

- 1 Press **FLASHBACK** to switch to the previously tuned channel.
- 2 Press **FLASHBACK** again to switch back to the currently tuned channel.

#### NOTE

- **FLASHBACK** will not work if no channel has been changed after the TV is turned on.

### Method 3

Using remote control buttons **0-9**, **•** (DOT) to select channels for VHF/UHF/CATV/DIGITAL.

#### To select a 1 or 2-digit channel number (e. g., Channel 5):

Press 5 → **ENT**



#### NOTE

- When selecting a 1-digit channel number, it is not necessary to press **0** before the number.
- When you enter **0-9** only, channel selection will be made if there is no operation within a few seconds.

#### To select a 3-digit channel number (e. g., Channel 115):

Press 1 → 1 → 5



#### To select a 4-digit channel number (e. g., Channel 22.1):

Press 2 → 2 → **•** (DOT) → 1 → **ENT**



#### NOTE

- When you enter **0-9** only, channel selection will be made if there is no operation within a few seconds.
- If you push "0" by itself, nothing will happen.
- Complete the above steps within a few seconds.
- When you enter **0-9** and **•** (DOT), channel selection will be made if there is no operation within a few seconds.

## Watching TV

### Simple button operations for changing volume/sound

#### Changing the volume

You can change the volume on the TV or on the remote control unit.

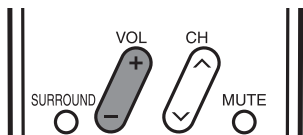
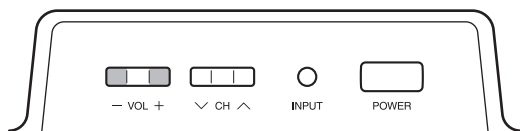

#### Using VOL +/-

- To increase the volume, press **VOL +**.
- To decrease the volume, press **VOL -**.

#### Volume adjustment



#### NOTE

- **VOL -/+** on the TV operates the same as **VOL +/-** on the remote control unit.

#### Audio status

Output device	Output Select	
	Fixed	Variable
Speaker	Variable sound	Mute

\* When "Output Select" is set to "Variable", the indicator on the screen changes as shown below.



#### NOTE

- See page 52 for details on the Output Select function.

#### Using MUTE on the remote control unit

Mutes the current sound output.

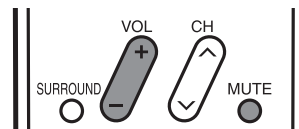

Press **MUTE**.

-  will be displayed on the screen for 30 minutes, and the sound is silenced.

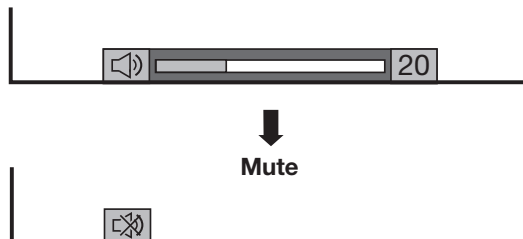

#### NOTE

- Within 30 minutes of pressing **MUTE**, mute can be canceled by using one of the methods below.
  - Mute will cancel if you press **VOL -/+** or **MUTE**.
- Mute will be canceled after 30 minutes have passed. However, the TV will not suddenly output a loud sound as the volume level is set to 0 automatically.

#### Using SURROUND on the remote control unit

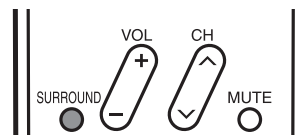

**SURROUND** produces Surround effect from the speakers. Each time you press **SURROUND**, the mode changes between On and Off.

#### Surround sound options

On: Makes it possible to enjoy natural, realistic surround sound.

Off: Outputs the normal sound.



#### NOTE

- You can have the same settings by choosing "Surround" on the menu items. (See page 26.)

## Watching TV

### Setting MTS/SAP stereo mode

The TV has a feature that allows reception of sound other than the main audio for the program. This feature is called Multi-channel Television Sound (MTS). The TV with MTS can receive mono sound, stereo sound and Secondary Audio Programs (SAP). The SAP feature allows a TV station to broadcast other information, which could be audio in another language or something completely different like weather information.

**You can enjoy Hi-Fi stereo sound or SAP broadcasts where available.**

- **Stereo broadcasts**

View programs like live sporting events, shows and concerts in dynamic stereo sound.

- **SAP broadcasts**

Receive TV broadcasts in either MAIN or SAP sound.

MAIN sound: The normal program soundtrack (either in mono or stereo).

SAP sound: Listen to a second language, supplementary commentary or other information. (SAP is mono sound.)

**If stereo sound is difficult to hear.**

- Obtain a clearer sound by manually switching to fixed mono-sound mode.

**NOTE**

- MTS only operates while in TV mode.

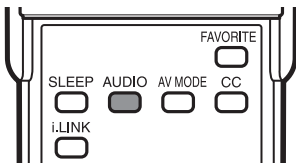

You can change MTS as shown below to match the television broadcast signal.

#### Examples: when receiving MTS and SAP

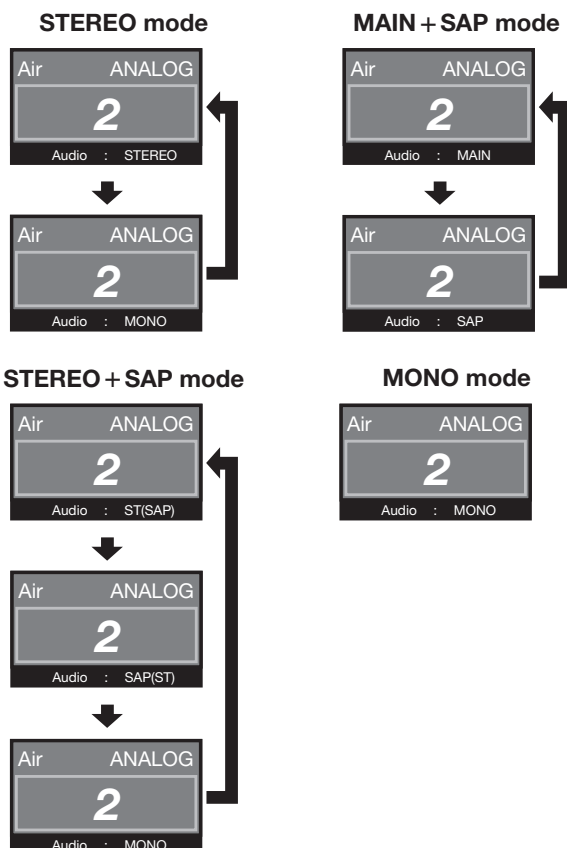

### Setting Digital broadcasting audio mode

The types of audio transmitted in a digital broadcast include SURROUND as well as MONO and STEREO. In addition, it is possible for multiple audio tracks to accompany a single video track.

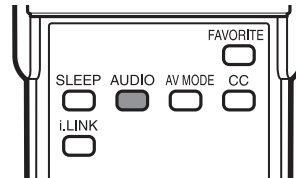

Press **AUDIO** to toggle between audio modes.

#### Examples: when receiving Digital broadcasting

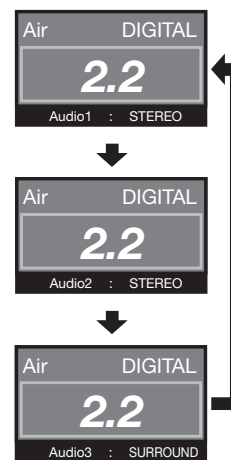

# Basic adjustment settings

## Menu operation buttons

Use the following buttons on the remote control to operate the menu.

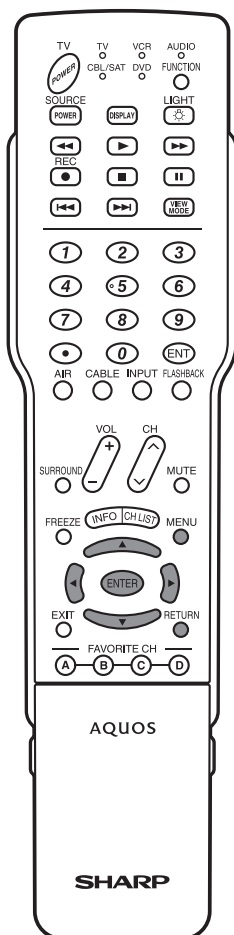

**MENU:** Press to open or close the menu screen.

**▲/▼/◀/▶:** Press to select a desired item on the screen or adjust a selected item.

**ENTER:** Press to go to the next step or complete the setting.

**RETURN:** Press to return to the previous step.

◀▶: Select    ENTER: Enter    RETURN: Back    MENU: Exit

The bar above is an operational guide for the remote control. The bar will change in accordance with each menu setting screen.

## On-Screen Display

### Example

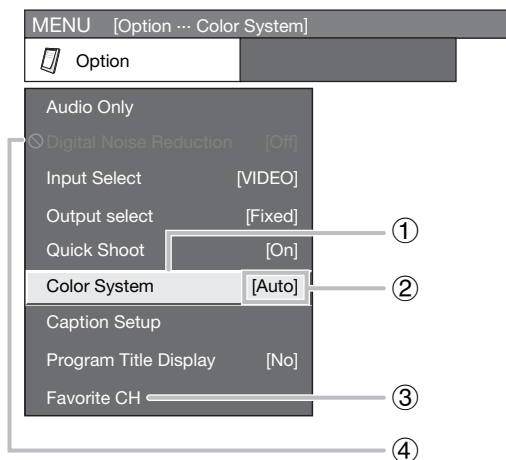

① Item displayed in yellow

- This indicates the item currently selected.
- Press **ENTER** to go to the adjustment screen for this item.

② Item in brackets

- This indicates the current setting for the item.

③ Item displayed in white

- This indicates an item can be selected.

④ Item displayed in grey

- This indicates that the item cannot be selected.
- \*There are various reasons why items cannot be selected, but the main reasons are as follows:

- Nothing is connected to the selected input terminal.
- The function is not compatible with the current input signal.

### NOTE

- Menu options differ in the selected input modes, but the operating procedures are the same.
- The screens in the operation manual are for explanation purposes (some are enlarged, others cropped) and may vary slightly from the actual screens.

Menu items for TV/INPUT 1/INPUT 2

 Picture

OPC.....	Page 24
Backlight .....	Page 24
Contrast .....	Page 24
Brightness .....	Page 24
Color .....	Page 24
Tint .....	Page 24
Sharpness .....	Page 24
Advanced	
Color Temp. ....	Page 25
Black .....	Page 25
3D-Y/C .....	Page 25
Monochrome.....	Page 25
Film Mode .....	Page 25
Range of OPC .....	Page 25

 Audio

Treble .....	Page 26
Bass .....	Page 26
Balance.....	Page 26
Surround.....	Page 26

 Power Control

No Signal Off.....	Page 27
No Operation Off .....	Page 27

 Setup

EZ Setup.....	Page 21
CH Setup .....	Page 21
Antenna Setup-DIGITAL.....	Page 22
Input Skip .....	Page 44
Input Label .....	Page 48
Parental CTRL.....	Pages 56-61
Position.....	Page 44
Picture Flip .....	Page 48
Standby Mode.....	Page 44
Language.....	Page 44
Reset.....	Page 46

 Option

Audio Only .....	Page 52
Digital Noise Reduction .....	Page 52
Input Select .....	Page 47
Output Select .....	Page 52
Quick Shoot .....	Page 52
Color System .....	Page 53
Caption Setup .....	Page 55
Program Title Display .....	Page 53
Favorite CH .....	Page 23

 Digital Setup

Audio Setup.....	Page 28
i.LINK Setup .....	Page 34

Menu items for HDMI/DVI

 Picture

OPC.....	Page 24
Backlight .....	Page 24
Contrast .....	Page 24
Brightness .....	Page 24
Color .....	Page 24
Tint .....	Page 24
Sharpness .....	Page 24
Advanced	
Color Temp. ....	Page 25
Black .....	Page 25
Monochrome.....	Page 25
Film Mode .....	Page 25
Range of OPC .....	Page 25

 Audio

Treble .....	Page 26
Bass .....	Page 26
Balance.....	Page 26
Surround.....	Page 26

 Power Control

No Signal Off.....	Page 27
No Operation Off .....	Page 27

 Setup

Input Skip .....	Page 44
Input Signal .....	Page 51
Auto Sync. ....	Page 45
Input Label .....	Page 48
Fine Sync. ....	Page 45
Position.....	Page 44
Picture Flip .....	Page 48
Standby Mode.....	Page 44
Language.....	Page 44
Reset.....	Page 46

 Option

Audio Only .....	Page 52
Digital Noise Reduction .....	Page 52
Input Select .....	Page 47
HDMI Setup .....	Page 31
Output Select .....	Page 52
Quick Shoot .....	Page 52

 Digital Setup

i.LINK Setup .....	Page 34
--------------------	---------

## Basic adjustment settings

### EZ Setup

You can run EZ Setup again, even after setting up the preset channels.

#### Language setting

Select from among 3 languages: English, French and Spanish.

- 1 Press **MENU** and the MENU screen displays.
- 2 Press ◀/▶ to select "Setup".
- 3 Press ▲/▼ to select "EZ Setup", and then press **ENTER**.
  - If you already set the Secret No., go to step 4. If not, skip to step 5.
- 4 Input the 4-digit secret number by using 0–9.
- 5 Press ▲/▼ to select the desired language listed on the screen, and then press **ENTER**.

#### Channel search

Channel auto search makes the TV look for all channels viewable in the set area.

- 6 Press ◀/▶ to select "Yes" or "No" for AIR Analog & Digital, then press ▼ to move down.  
Press ◀/▶ to select "Yes" or "No" for CABLE Analog, then press ▼ to move down.  
Press ◀/▶ to select "Yes" or "No" for CABLE Analog & Digital, then press ▼ to move down.  
Select "Search Start", and then press **ENTER**.
  - If you are only receiving an analog signal through the cable, select "Yes" for CABLE Analog. If you are receiving both an analog signal and a digital signal through the cable, select "Yes" for CABLE Analog & Digital.
- 7 Press **MENU** to exit.

#### NOTE

- If no channel is found, confirm the type of connection made with your TV and try EZ Setup again.
- If you select "Yes" for CABLE Analog and initiate the channel search, the channel list for CABLE Digital will be deleted.

### Channel Setup

If initial setup does not memorize all the channels in your region, follow the instructions below to manually memorize the channels.

#### Channel search

Channel auto search makes the TV look for all channels viewable in the set area.

- 1 Press **MENU** and the MENU screen displays.
- 2 Press ◀/▶ to select "Setup".
- 3 Press ▲/▼ to select "CH Setup", and then press **ENTER**.
  - If you already set the Secret No., input the 4-digit secret number here. See page 56 for setting a secret number.
- 4 Press ▲/▼ to select "CH Search", and then press **ENTER**.
- 5 Press ◀/▶ to select "Yes" or "No" for AIR Analog & Digital, then press ▼ to move down.  
Press ◀/▶ to select "Yes" or "No" for CABLE Analog, then press ▼ to move down.  
Press ◀/▶ to select "Yes" or "No" for CABLE Analog & Digital, then press ▼ to move down.  
Select "Search Start", and then press **ENTER**.
  - If you are only receiving an analog signal through the cable, select "Yes" for CABLE Analog. If you are receiving both an analog signal and a digital signal through the cable, select "Yes" for CABLE Analog & Digital.
- 6 Press **MENU** to exit.

#### NOTE

- If no channel is found, confirm the type of connection made with your TV and try channel search again.
- If you select "Yes" for CABLE Analog and initiate the channel search, the channel list for CABLE Digital will be deleted.

## Basic adjustment settings

### Channel memory setting

**1** Press **MENU** and the MENU screen displays.

**2** Press **◀/▶** to select "Setup".

**3** Press **▲/▼** to select "CH Setup", and then press **ENTER**.

- If you already set the Secret No., input the 4-digit secret number here. See page 56 for setting a secret number.

**4** Press **▲/▼** to select "CH Memory", and then press **ENTER**.

**5** Press **▲/▼** to select ANALOG (Air), ANALOG (Cable), DIGITAL (Air) or DIGITAL (Cable), and then press **ENTER**.

#### **6** When viewing ANALOG broadcasts:

- ① Press **◀/▶** to select the channel to skip, and then press **▼** to move down.
- ② Press **◀/▶** to select "On", and then press **ENTER**.

#### When viewing DIGITAL broadcasts:

- ① Press **▲/▼** to select the channel to skip, and then press **◀/▶** to select "On".

- On: Skips channels. (Channel selection disabled using **CH ▲/▼**.)
- Off: Does not skip channels. (Channel selection enabled using **CH ▲/▼**.)

**7** Press **MENU** to exit.

#### **NOTE**

- Make sure what kind of connection is made with your TV.

### Antenna Setup - DIGITAL

In order to receive digital air broadcasts, you need a digital broadcast antenna. You can confirm the antenna configuration through the "Antenna Setup - DIGITAL" screen.

If necessary, adjust the direction of the antenna to obtain the maximum signal strength.

#### Signal Strength

**1** Press **MENU** and the MENU screen displays.

**2** Press **◀/▶** to select "Setup".

**3** Press **▲/▼** to select "Antenna Setup - DIGITAL", and then press **ENTER**.

**4** Press **▲/▼** to select "Signal Strength".

- The signal strength of DIGITAL channel is displayed. The signal information is based on the current channel.

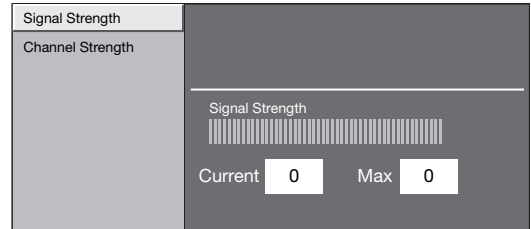

**5** Press **MENU** to exit.

### Channel Strength

The channel signal strength can also be checked separately.

**1** Repeat steps 1 to 3 in Signal Strength in **Antenna Setup - DIGITAL**

**2** Press **▲/▼** to select "Channel Strength", and then press **ENTER**.

**3** Input the 2-digit channel number to check the signal strength of the selected channel.

- Make sure the signal is strong enough for each channel.

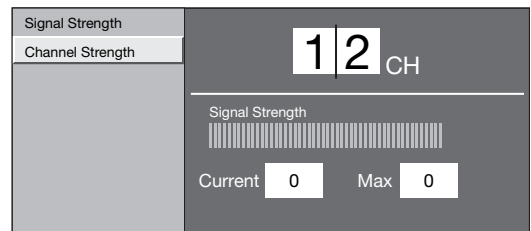

**4** Press **MENU** to exit.

#### **NOTE**

- This function is available for DIGITAL (Air) only.

## Basic adjustment settings

### Favorite channel setting

This function allows you to program 4 favorite channels, in 4 different categories. By setting the favorite channels in advance, you can select your favorite channels easily.

#### Using FAVORITE CH on the remote control unit

- 1 Select the channel you want to register as a favorite channel.
- 2 Press **FAVORITE**.
- 3 Press **▲/▼** to select “Register”, and then press **ENTER**.
- 4 Press **▲/▼/◀/▶** to select the position in the category, and then press **ENTER** to register.

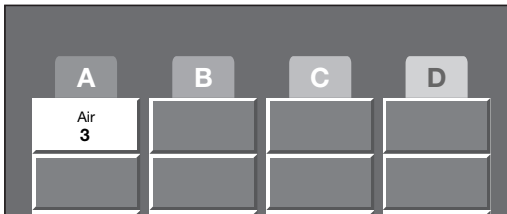

#### Deleting a favorite channel

- 1 Press **FAVORITE** and the favorite channel screen displays.
- 2 Press **▲/▼** to select “1 Data Clear”, and then press **ENTER**.
- 3 Press **▲/▼/◀/▶** to select the channel you want to delete, and then press **ENTER**.

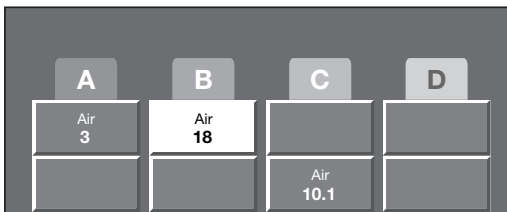

- 4 Press **◀/▶** to select “Yes”, and then press **ENTER**.



#### NOTE

- You can delete all the favorite channels by selecting “All Data Clear” in step 2 in **Deleting a favorite channel**.

#### Using Favorite CH on the menu screen

You can also set your favorite channels in “Option” on the MENU screen.

- 1 Select the channel you want to register as a favorite channel.
- 2 Press **MENU** and the MENU screen displays.
- 3 Press **◀/▶** to select “Option”.
- 4 Press **▲/▼** to select “Favorite CH”, and then press **ENTER**.
- 5 Press **▲/▼** to select “Register”, and then press **ENTER**.
- 6 Press **▲/▼/◀/▶** to select the position in the category, and then press **ENTER** to register.
- 7 Press **MENU** to exit.

#### Deleting a favorite channel

- 1 Repeat steps 2 to 4 in **Using Favorite CH on the menu screen**.
- 2 Press **▲/▼** to select “1 Data Clear”, and then press **ENTER**.
- 3 Press **▲/▼/◀/▶** to select the channel you want to delete, and then press **ENTER**.
- 4 Press **◀/▶** to select “Yes”, and then press **ENTER**.
- 5 Press **MENU** to exit.

#### NOTE

- You can delete all the favorite channels by selecting “All Data Clear” in step 2 in **Deleting a favorite channel**.



## Basic adjustment settings

### Picture adjustments

Adjusts the picture to your preference with the following picture settings.

- 1 Press **MENU** and the MENU screen displays.
- 2 Press **◀/▶** to select "Picture".
- 3 Press **▲/▼** to select a specific adjustment item.
- 4 Press **◀/▶** to adjust the item to the desired level.
- 5 Press **MENU** to exit.

#### NOTE

- For resetting all Picture adjustment items to the factory preset values, press **▲/▼** to select "Reset", press **ENTER**, press **◀/▶** to select "Yes", and then press **ENTER**.

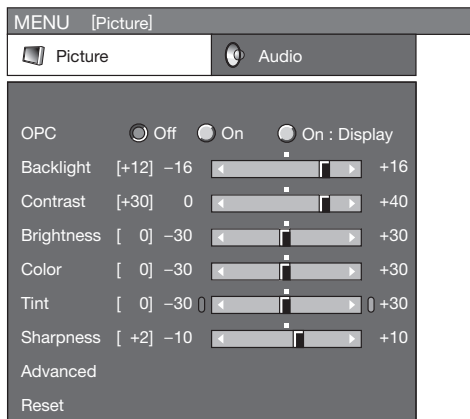

Selected item	◀ button	▶ button
<b>Backlight</b>	The screen dims	The screen brightens
<b>Contrast</b>	For less contrast	For more contrast
<b>Brightness</b>	For less brightness	For more brightness
<b>Color</b>	For less color intensity	For more color intensity
<b>Tint</b>	Skin tones become purplish	Skin tones become greenish
<b>Sharpness</b>	For less sharpness	For more sharpness

#### NOTE

- Select "Advanced" and then press **ENTER** to set "Color Temp.", "Black", "3D-Y/C", "Monochrome", "Film Mode" or "Range of OPC". See page 25.

### OPC setting

Automatically adjusts the brightness of the screen.

- 1 Press **MENU** and the MENU screen displays.
- 2 Press **◀/▶** to select "Picture".
- 3 Press **▲/▼** to select "OPC".
- 4 Press **◀/▶** to select "On" or "On: Display".

Selected item	Description
<b>Off</b>	The brightness is fixed at the value set in "Backlight".
<b>On</b>	Automatically adjusts
<b>On: Display</b>	Displays the OPC effect on the screen while adjusting the brightness of the screen.

- 5 Press **MENU** to exit.

#### NOTE

- When set to "On", the OPC senses the surrounding light and automatically adjusts the backlight brightness. Make sure nothing obstructs the OPC sensor, which could affect its ability to sense surrounding light.
- When set to "On: Display", OPC effect displays on the screen while the OPC adjusts the screen brightness.

## Basic adjustment settings

### Advanced picture adjustments

This TV provides various advanced functions for optimizing the picture quality.

- 1 Press **MENU** and the MENU screen displays.
- 2 Press **◀/▶** to select "Picture".
- 3 Press **▲/▼** to select "Advanced", and then press **ENTER**.
- 4 Press **▲/▼** to select a specific adjustment item, and then press **ENTER**.
  - You can select "Color Temp.", "Black", "3D-Y/C", "Monochrome", "Film Mode" or "Range of OPC".
- 5 Press **▲/▼** (or **◀/▶**) to select the desired parameter.
  - See the table for the selectable parameters.
- 6 Press **MENU** to exit.

### Color Temperature

For a better white balance, use color temperature correction.

Selected item	Description
High Mid-High Middle Mid-Low Low	White with Bluish tone  ↑↓  White with Reddish tone

### Black

Changes the viewing depth by automatically adjusting the dark portion of an image for easier viewing.

Selected item	Description
Off	No adjustment
On	For high detail in black portions

### 3D-Y/C

Provides high quality images with minimal dot crawl and cross color noise.

Selected item	Description
Standard	Normal adjustment
Fast	For moving images
Slow	For still images

### NOTE

- 3D-Y/C is available for input signal from Composite Video and ANALOG IN.

### Monochrome

For viewing a video in monochrome.

Selected item	Description
Off	Normal color
On	For viewing in monochrome

### Film Mode (3:2 pull-down)

Automatically detects a film-based source (originally encoded at 24 frames/second), analyzes it then recreates each still film frame for high-definition picture quality.

Selected item	Description
Off	Normal viewing mode
On	Detects, analyzes, converts film source

### Range of OPC

The brightness level range of the OPC sensor's automatic adjustments can be set according to your preferences. The adjustment range of the OPC sensor can be set to a maximum of +16 and a minimum of -16.

Selected item	Description
Max.	-15 through +16
Min.	-16 through +15

### NOTE

- The range of OPC settings are active only when the OPC is set to On.
- The maximum setting cannot be set to a smaller number than the minimum setting.
- The minimum setting cannot be set to a bigger number than the maximum setting.
- Depending on the brightness of the surrounding light, the OPC sensor might not operate if the adjustment range is small.

## Basic adjustment settings

### Sound adjustment

You can adjust the sound quality to your preference with the following settings.

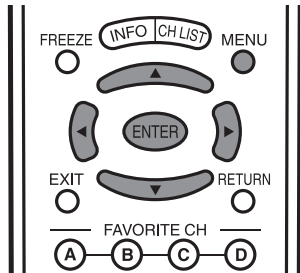

**1** Press **MENU** and the MENU screen displays.

**2** Press **◀/▶** to select “Audio”.

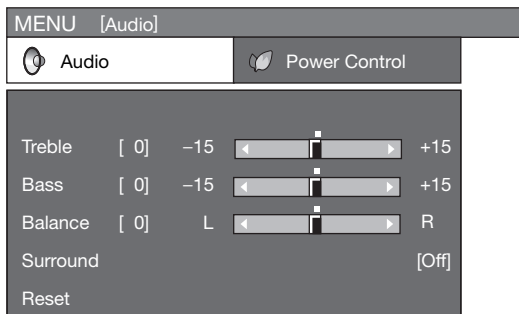

**3** Press **▲/▼** to select a specific adjustment item.

**4** Press **◀/▶** to adjust the item to the desired level.

Selected item	◀ button	▶ button
<b>Treble</b>	For weaker treble	For stronger treble
<b>Bass</b>	For weaker bass	For stronger bass
<b>Balance</b>	Decrease audio from the right speaker	Decrease audio from the left speaker

**5** Press **MENU** to exit.

#### NOTE

- Audio menu is grayed out when Output Select is set to “Variable”.
- For resetting all Audio adjustment items to the factory preset values, press **▲/▼** to select “Reset”, press **ENTER**, press **◀/▶** to select “Yes”, and then press **ENTER**.

### Surround

Surround effects can be set using the “Audio” menu.

**1** Press **MENU** and the MENU screen displays.

**2** Press **◀/▶** to select “Audio”.

**3** Press **▲/▼** to select “Surround”, and then press **ENTER**.

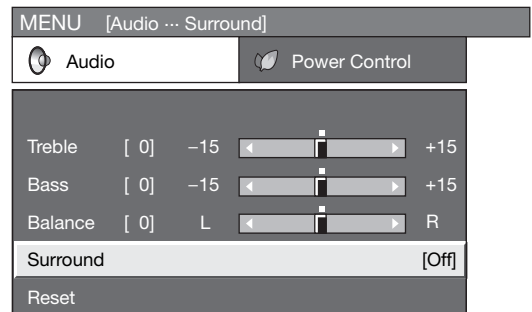

**4** Press **◀/▶** to select “On”, and then press **ENTER**.

**5** Press **MENU** to exit.

#### NOTE

- You can choose Surround by pressing **SURROUND** on the remote control unit.
- Audio menu is grayed out when Output Select is set to “Variable”.
- For some discs, setup may be required on your DVD player. In this case, please refer to the operation manual of your DVD player.

## Basic adjustment settings

---

### Power Control

Power control setting allows you to save energy.

#### No signal off

When set to "Enable", the power will automatically shut down if there is no signal for 15 minutes.

**1** Press **MENU** and the MENU screen displays.

**2** Press **◀/▶** to select "Power Control".

**3** Press **▲/▼** to select "No Signal Off", and then press **ENTER**.

**4** Press **◀/▶** to select "Enable", and then press **ENTER**.

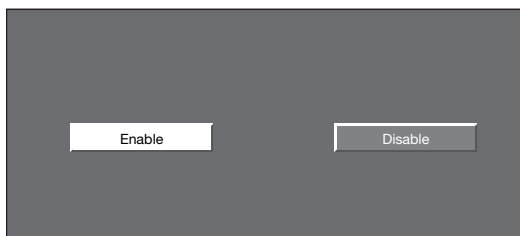

- Five minutes before the power shuts down, the remaining time displays every minute.

**5** Press **MENU** to exit.

#### NOTE

- "Disable" is the factory preset value.
- When a TV program finishes, this function may not operate.

#### No operation off

When set to "Enable", the power will automatically shut down if there is no operation for 3 hours.

**1** Repeat steps 1 and 2 in **No signal off**.

**2** Press **▲/▼** to select "No Operation Off", and then press **ENTER**.

**3** Press **◀/▶** to select "Enable", and then press **ENTER**.

- Five minutes before the power shuts down, the remaining time displays every minute.

**4** Press **MENU** to exit.

#### NOTE

- "Disable" is the factory preset value.

## Basic adjustment settings

### Digital Setup

This setting allows you to optimize the settings of Digital broadcasting.

### Audio Setup

You can output digital audio to an AV amplifier or similar device whose DIGITAL AUDIO INPUT terminal is connected to the DIGITAL AUDIO OUTPUT terminal on the TV. Please select an audio output format compatible with the audio format of the program you are watching and the equipment connected.

**1** Press **MENU** and the MENU screen displays.

**2** Press **◀/▶** to select “Digital Setup”.

**3** Press **▲/▼** to select “Audio Setup”, and then press **ENTER**.

**4** Press **▲/▼** to select “PCM” or “Dolby Digital”, and then press **ENTER**.

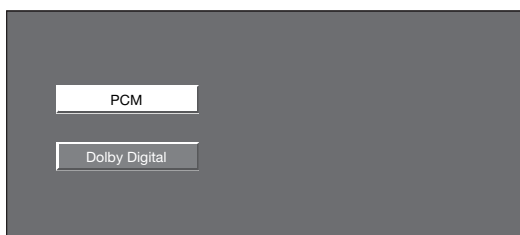

Selected item	Description
<b>PCM</b>	The optical output terminal outputs audio signal in PCM form. If your digital audio system does not support Dolby Digital, select “PCM”.
<b>Dolby Digital</b>	The optical output terminal outputs audio signal in Dolby Digital form. It reproduces sound from surround program of digital.

**5** Press **MENU** to exit.

# Using external equipment

You can connect many types of external equipment to your TV like a DVD player, VCR, Digital TV tuner, PC, HDMI equipment, game console or camcorder. To view external source images, select the input source from **INPUT** on the remote control unit or on the TV.

## Displaying an external equipment image

This explanation is for the setting when connecting a DVD player to the INPUT1 terminal.

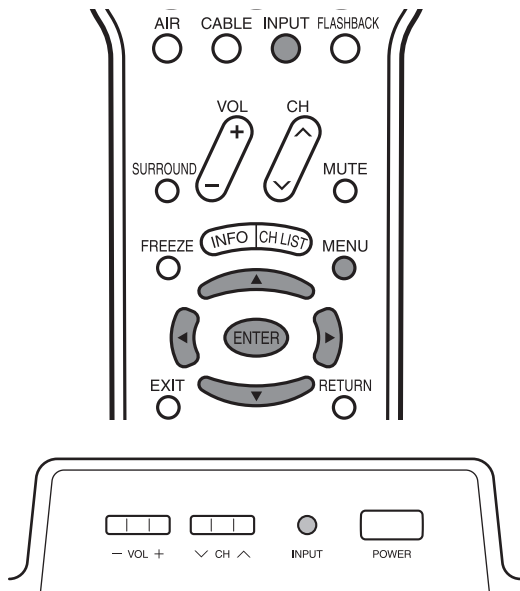

To watch a DVD image, select "INPUT1" from "INPUT SOURCE" menu using **INPUT** on the remote control unit or on the TV. (See page 47.)

(Example)

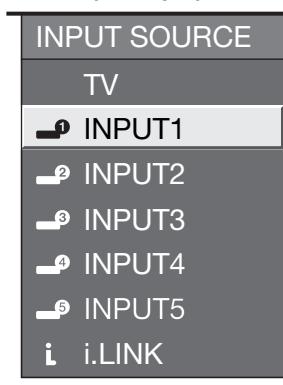

### NOTE

- If the image does not come in clearly, you may need to change the input signal type setting on the "Input Select" menu.

## Selecting the INPUT signal

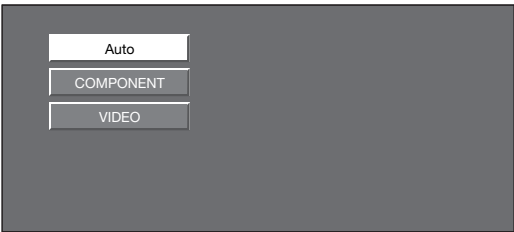
- 1 Press **MENU** and the MENU screen displays.
- 2 Press **◀▶** to select "Option".
- 3 Press **▲▼** to select "Input Select", and then press **ENTER**.
- 4 Press **▲▼** to select the desired signal type, and then press **ENTER**.  
 For INPUT1 signal
 
- 5 Press **MENU** to exit.

The setting is stored and can be selected on the "INPUT SOURCE" menu.

### CAUTION

- To protect equipment, always turn off the TV before connecting a DVD player, VCR, Digital TV tuner, PC, HDMI equipment, game console, camcorder or other external equipment.

### NOTE

- See pages 30 to 34 for external equipment connection.
- Please read the relevant operation manual (DVD player, etc.) carefully before making connections.
- Each time **INPUT** is pressed, the input source toggles.
- Refer to your external equipment operation manual for the signal type.

## Using external equipment

### Connecting a DVD player or a Digital TV STB (Air or Cable)

You can use the INPUT 1, INPUT 2 or INPUT 5 terminals when connecting to a DVD player, a Digital TV STB (Air or Cable) and other audiovisual equipment.

#### When using component cable. (INPUT 1)

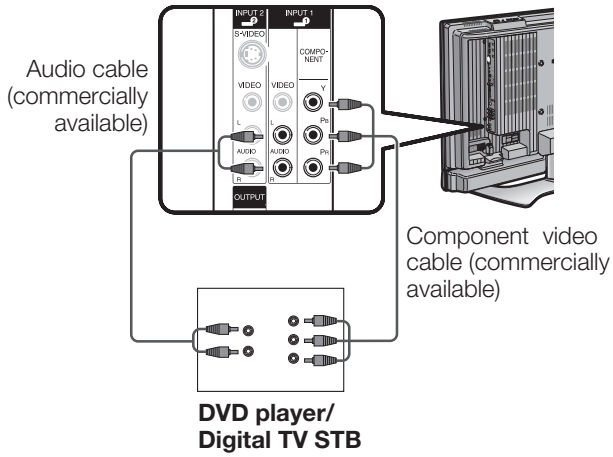

#### When using composite cable. (INPUT 1 or 2)

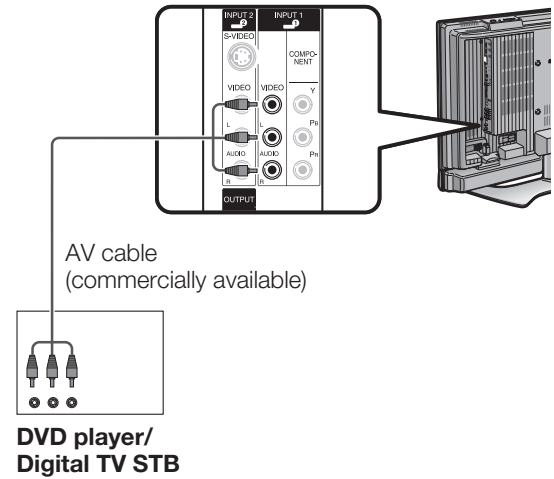

#### When using DVI cable. (INPUT 5)

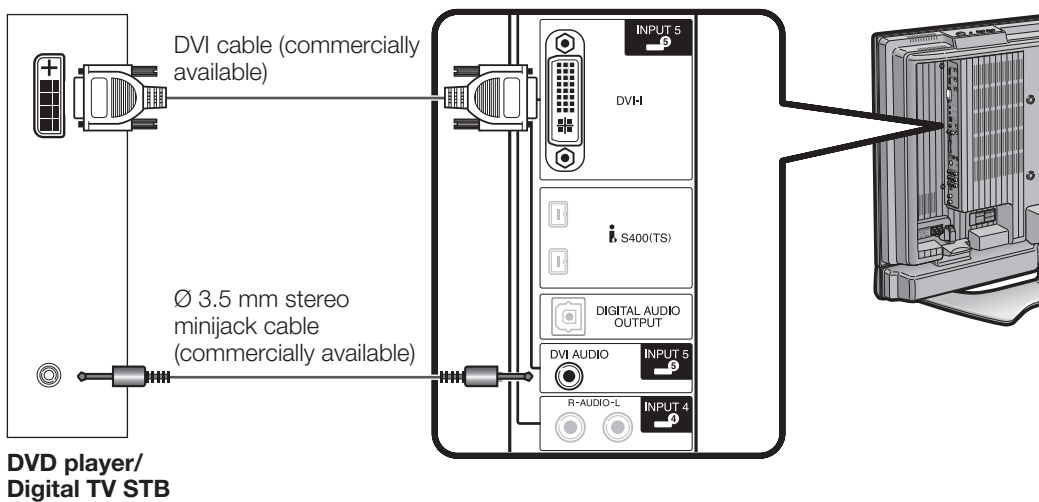

#### NOTE

- See page 31 for connecting a DVD player or a Digital TV STB to the HDMI terminal.

## Using external equipment

### Connecting HDMI equipment

You can use the INPUT 3 or INPUT 4 terminal when connecting HDMI equipment.

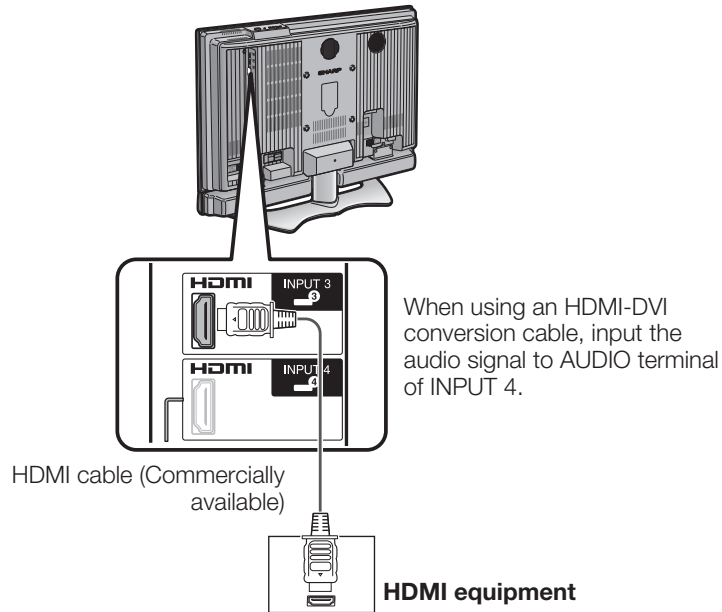

### Displaying an image from HDMI equipment

- To watch an HDMI equipment image, select "INPUT3" or "INPUT4" from "INPUT SOURCE" menu using **INPUT** on the remote control unit or on the TV. (See page 47.)

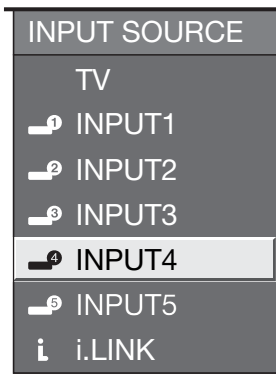

- Press **MENU** and the MENU screen displays.

- Press **◀/▶** to select "Option".

- Press **▲/▼** to select "HDMI Setup", and then press **ENTER**.

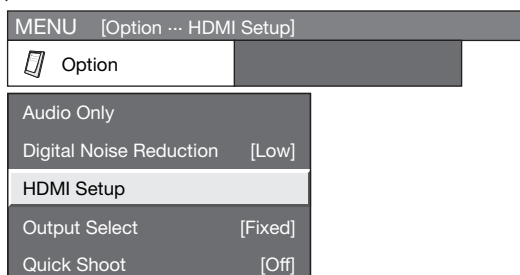

- Press **▲/▼** to select the desired item, and then press **ENTER**.

- Press **▲/▼/◀/▶** to select the desired setting, and then press **ENTER**.

HDMI Setup items	Selectable items	Description
<b>Signal Type</b>	RGB/YCbCr 4:4:4/ YCbCr 4:2:2	Select the video signal type from the HDMI terminal.
<b>Auto View</b>	Enable/Disable	Set whether or not to use View Mode based on signal recognition, including an HDMI signal.
<b>Audio Select</b>	Digital/Analog	Select "Digital" for an audio signal via the HDMI terminal. Select "Analog" for an audio signal via the R-AUDIO -L terminal.

- Press **MENU** to exit.

#### NOTE

- Refer to your external equipment operation manual for the signal type.
- "Signal Type" is only available when an HDMI-DVI conversion cable is connected.
- "Audio Select" is only available for INPUT 4.



## Using external equipment

### Connecting a PC

Use the INPUT 5 terminal to connect a PC.

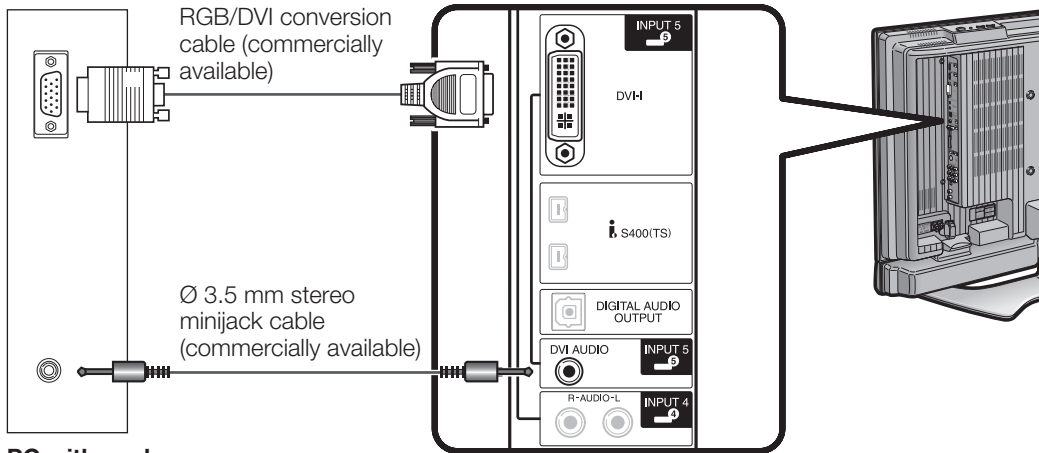

PC with analog RGB terminal

#### NOTE

- Refer to page 70 for a list of PC signals compatible with the TV.
- If you are connecting the TV to a PC with a DVI terminal, use a DVI cable (commercially available) instead of a RGB/DVI conversion cable.

### Connecting a VCR, game console or camcorder

A VCR, game console, camcorder and other audiovisual equipment can be conveniently connected using the INPUT 1 or 2 terminals.

#### NOTE

- The S-video terminal takes priority over the video terminals. (INPUT 2 only)

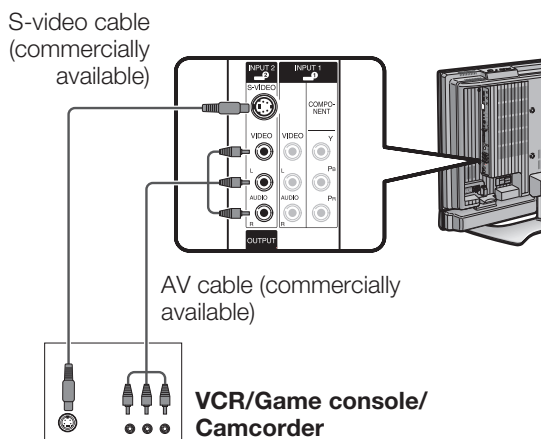

VCR/Game console/  
Camcorder

### Using Digital Audio Output

It is possible to output audio through the DIGITAL AUDIO OUTPUT terminal. (See page 28 for details.) PCM audio outputs from the terminal.

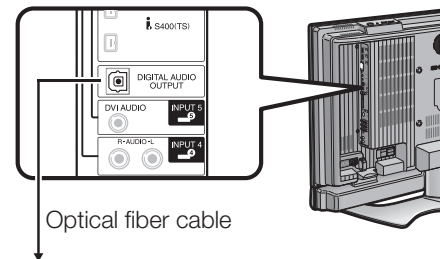

To optical digital input of external audio devices

## Using external equipment

### Connecting D-VHS decks/AV-HDD recorder/Blu-ray Disc recorder/Digital STB/Digital TV/HDV camcorder (i.LINK connection)

#### About i.LINK

i.LINK is an interface connection using a serial transfer system and is able to transfer multimedia data, such as digital images and digital sound, between devices that have i.LINK terminals. i.LINK is a term defined in the IEEE1394 (Institute of Electrical and Electronics Engineers) standard. Currently, the transfer speeds are at 100 Mbps, 200 Mbps and 400 Mbps, each of them expressed as S100, S200 and S400 respectively. On this TV, the maximum speed is 400 Mbps.

#### i.LINK devices that can be connected to this TV

D-VHS decks, AV-HDD recorders, Blu-ray Disc recorders, HDV camcorders, STBs and TVs can be connected to this TV via i.LINK. Other devices such as DVD recorders, non-HDV camcorders, computers or computer peripheral devices do not meet the specifications for this TV and therefore cannot be connected via i.LINK. Even for the types of i.LINK device mentioned above, device recognition, control, recording and playback operations may not be possible on some devices.

#### Materials that can be recorded with the i.LINK

Only digital programs can be recorded by i.LINK devices connected to this TV using the i.LINK. i.LINK recording is not compatible with analog broadcasts or external input signals (INPUT terminals 1 through 5).

#### i.LINK connection

##### NOTE

- Please make sure the shapes of the terminal and the plug match, and insert the plug into the terminal straight, not on an angle.
- Use either one of the terminals. These two terminals do not differ in quality or function.

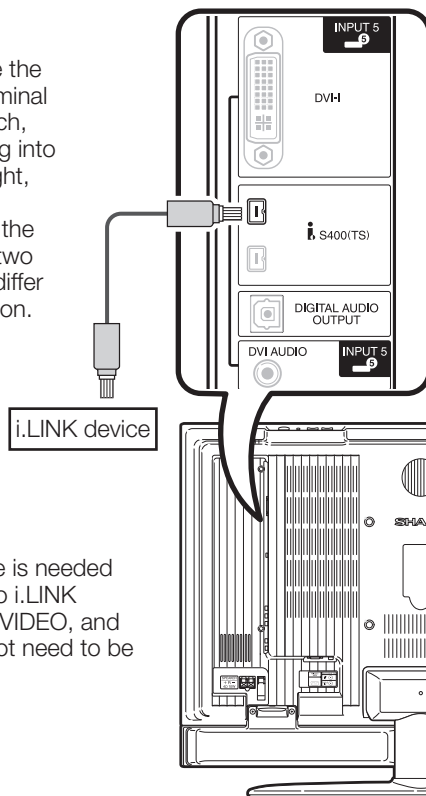

Only an i.LINK cable is needed to connect the TV to i.LINK devices. (VIDEO, S-VIDEO, and AUDIO cables do not need to be connected.)

### Connecting two or more i.LINK devices

Up to 16 i.LINK devices can be connected using a daisy-chain connection with i.LINK cables.

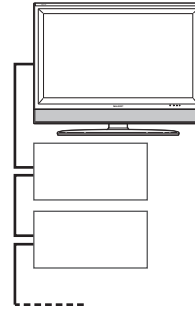

When 3 or more i.LINK devices are connected, branch connection can be used. With branch connections, up to 62 i.LINK devices can be connected.

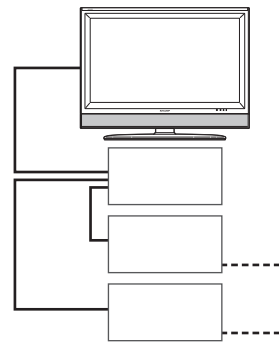

#### Cautions regarding i.LINK connection

- Please use S400 type i.LINK cables.
- Some i.LINK devices may not relay data if their power is off. In this case the device should be connected at the end of any series of connections.
- This TV can relay data during power off, by selecting "Active" in the "Standby Mode" option in "i.LINK Setup". (See page 35.)
- Please do NOT use a loop connection as shown in the diagram.

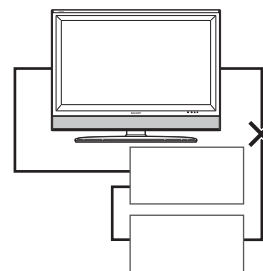

- When any devices are playing or recording via i.LINK, do not turn off the power of, or disconnect the cable from any of the i.LINK devices, even if one or more of the i.LINK devices are not in use. Doing so may affect the picture and the sound from an i.LINK device in use.
- If devices such as DVD recorders, non-HDV camcorders, computers and computer peripheral devices that are not compatible with this TV are connected to the TV using i.LINK, other i.LINK connections may be disrupted.
- If device recognition, control, recording or play back, on an i.LINK connected device does not function correctly, correct operation may be restored by disconnecting and reconnecting the i.LINK cable.
- When connecting multiple i.LINK devices, depending on the specifications and the interoperability of the connected devices, their operation may not be stable. In that case, disconnecting all devices not in use and changing the method of connection may result in stable operation.

## Using external equipment

### Setting the input source (i.LINK)

If you want to receive an analog signal from the i.LINK device, you need to also use INPUT 1, INPUT 2, INPUT 3, INPUT 4 or INPUT 5 to connect the i.LINK device to the TV and follow the steps below to designate the INPUT you are using.

**Example: a Digital STB/Digital TV connected to the TV using i.LINK terminal and INPUT 2**

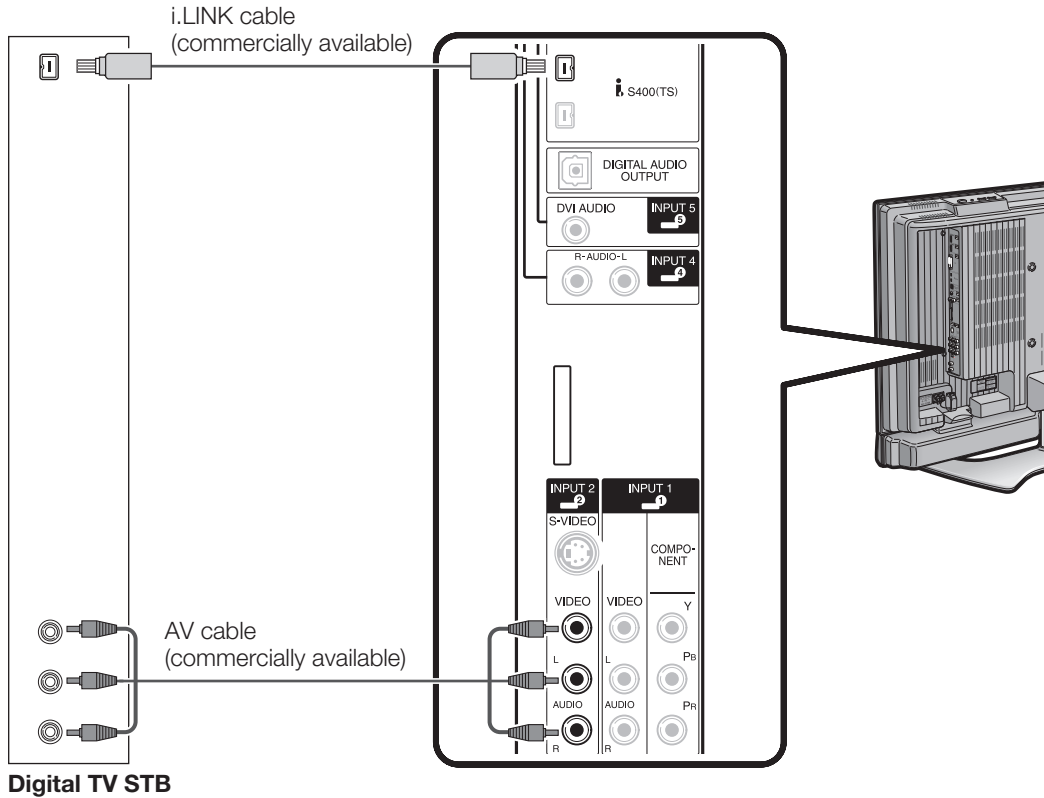

**1** Press **MENU** and the MENU screen displays.

**2** Press **◀/▶** to select "Digital Setup".

**3** Press **▲/▼** to select "i.LINK Setup", and then press **ENTER**.

**4** Press **▲/▼** to select "Input Select", and then press **ENTER**.

**5** Press **▲/▼** to select the input source.

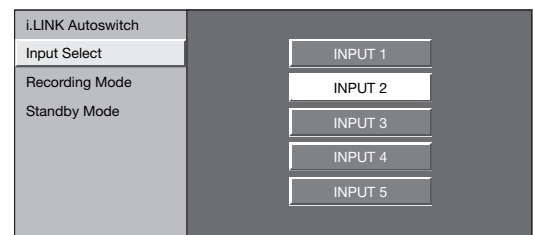

(Example)

**6** Press **MENU** to exit.

## Using external equipment

### Setting the Recording Mode (i.LINK)

The function for automatically adjusting the recording mode of connected i.LINK devices can be turned on or off.

Since most of the currently available i.LINK devices automatically recognize the transfer rates of the pictures and sound being recorded and control the recording mode accordingly, **you should always set this Mode to “Pass through” in normal circumstances.**

Depending on the i.LINK devices used and the type of broadcast being recorded, this TV may not adjust the recording mode properly. In this case, please set the “Recording Mode” to “Pass through”.

- 1 Press **MENU** and the MENU screen displays.
- 2 Press ◀▶ to select “Digital Setup”.
- 3 Press ▲▼ to select “i.LINK Setup”, and then press **ENTER**.
- 4 Press ▲▼ to select “Recording Mode”, and then press **ENTER**.
- 5 Press ◀▶ to select “Auto” or “Pass through”, and then press **ENTER**.
  - Normally, this should be set to “Pass through”.
- 6 Press **MENU** to exit.

### Setting the Standby Mode (i.LINK)

Power consumption during standby mode can be minimized by changing the setting of the “Standby Mode” in “i.LINK Setup”.

If you are not using i.LINK and want to save power at the standby, select “Inactive” in “Standby Mode”.

- 1 Press **MENU** and the MENU screen displays.
- 2 Press ◀▶ to select “Digital Setup”.
- 3 Press ▲▼ to select “i.LINK Setup”, and then press **ENTER**.
- 4 Press ▲▼ to select “Standby Mode”, and then press **ENTER**.
- 5 Press ◀▶ to select “Active” or “Inactive”, and then press **ENTER**.

Selected item	Description
<b>Active</b>	Power continues to pass through the i.LINK circuit so data can be relayed.
<b>Inactive</b>	Power consumption is minimized during stand-by mode. Data cannot be relayed at this setting.

- 6 Press **MENU** to exit.

#### NOTE

- When the main power of the TV is in standby mode (POWER indicator lights off), i.LINK control commands cannot be received from an i.LINK device. This does not change even if the “Standby Mode” is set to “Active”. To control the TV from an i.LINK device, turn the TV power on (POWER indicator lights up in blue).
- Data cannot be relayed between i.LINK devices when all the following conditions are met: 1) More than one i.LINK device is connected to the TV with i.LINK cables, 2) “Standby Mode” is set to “Inactive”, and 3) The power of the TV is in standby mode (POWER indicator lights off). When the TV is connected between two i.LINK devices in series, select “Active” in “Standby Mode” or connect the TV at an end of the series as shown in the diagram.

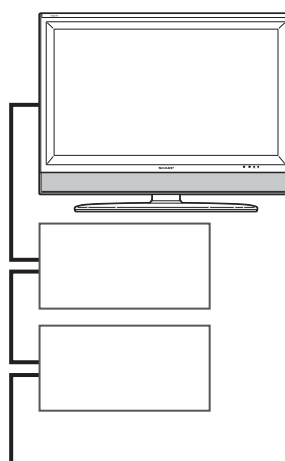

## Using external equipment

### Selecting an i.LINK device

In order to control an i.LINK device from the TV, you must first choose the i.LINK device to be controlled. One i.LINK device can be chosen from up to 16 i.LINK connected decks.

All i.LINK devices connected with i.LINK cables should automatically appear in the selection screen.

**1** Press **i.LINK** to display the i.LINK control panel.



- When there is no i.LINK device connected, the message "No i.LINK model is available" appears. In this case, please connect an i.LINK device. (See page 33.)
- When there is no i.LINK device selected, the selection screen appears. In this case, please go to step 3.

**2** Press **▲/▼/◀/▶** to select "Model", and then press **ENTER**.

- Selection screen appears.

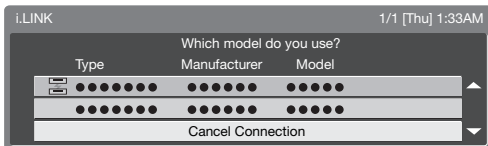

**3** Press **▲/▼** to select the device, and then press **ENTER**.

- The control panel for the i.LINK device appears.

#### NOTE

- Devices that cannot be used with this TV will not appear in the selection screen.
- Depending on the i.LINK devices connected, the manufacturer's name and model name of some devices may not display correctly.
- In the case where the manufacturer's and model names are not correctly displayed, disconnect the i.LINK cable. Follow the procedure for "Deleting registered i.LINK device" and cancel all i.LINK devices you have registered before reconnecting the i.LINK cable.
- When an item in the selection screen is grayed out, the item is not recognized by the TV and cannot be selected. (The item may not be connected properly.)

### Disabling the TV's operation of an i.LINK device

By disabling the TV's operation of an i.LINK device, the device can be operated from another i.LINK device.

**1** Press **i.LINK** to display the i.LINK control panel.



- When there is no i.LINK device connected, the message "No i.LINK model is available" appears. In this case, please connect an i.LINK device. (See page 33.)
- When there is no i.LINK device selected, the selection screen appears. In this case, please go to step 3.

**2** Press **▲/▼/◀/▶** to select "Model", and then press **ENTER**.

- Selection screen appears.

**3** Press **▼** to select "Cancel connection", and then press **ENTER**.

- Operation of the i.LINK device from the TV is disabled.

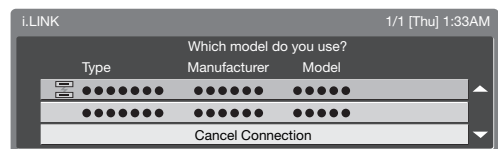

### Deleting registered i.LINK device

Registered i.LINK devices can be deleted from a list. If an i.LINK device is connected, it cannot be deleted from the list.

**1** Press **i.LINK** to display the i.LINK control panel.

**2** Press **▲/▼/◀/▶** to select "Model", and then press **ENTER**.

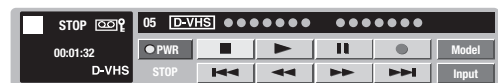

**3** Press **▼** to select a device to be deleted, and then press **ENTER**.

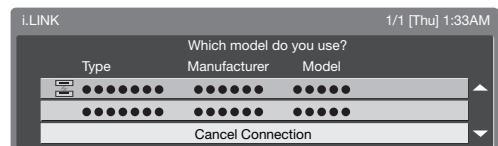

**4** Press **◀** to select "Delete", and then press **ENTER**.

- The selected i.LINK device is deleted from the list.
- Select "Cancel" if you do not want to delete any device.

## Using external equipment

### Controlling an i.LINK device

An i.LINK compatible device can be controlled from the TV using the i.LINK control panel on the screen.

- The steps in “i.LINK Setup” on pages 34 and 35 need to be completed beforehand.
- Please also refer to the operation manual of the i.LINK device to be used with this TV.

#### Basic operation

- ① Press **i.LINK** to display the i.LINK control panel.
  - The **i.LINK** button is also used to exit the i.LINK control panel.
- ② Press **▲/▼/◀/▶** to select a function, and then press **ENTER**.

#### i.LINK control panel (D-VHS decks)

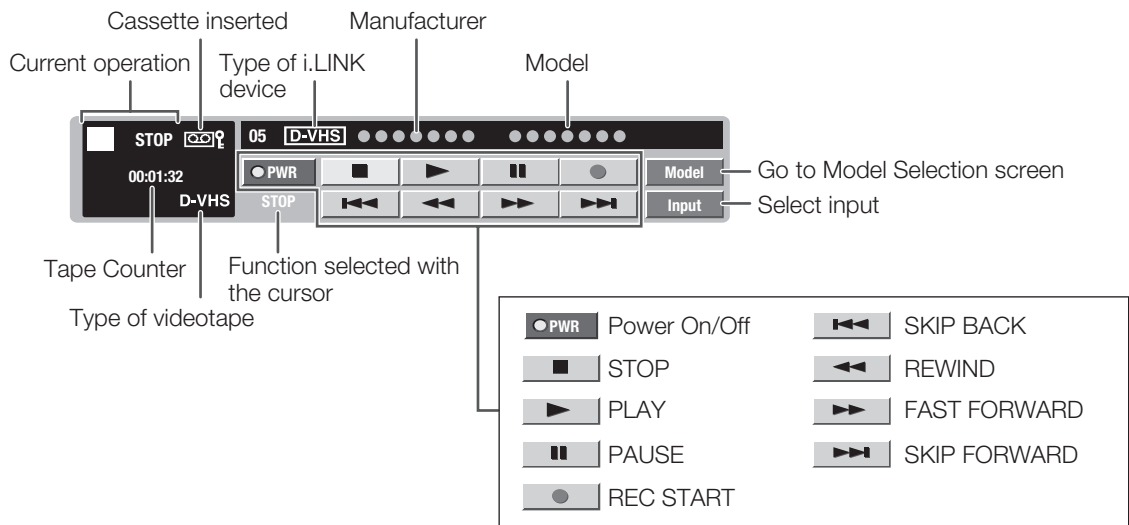

#### i.LINK control panel (AV-HDD recorder/Blu-ray Disc recorder)

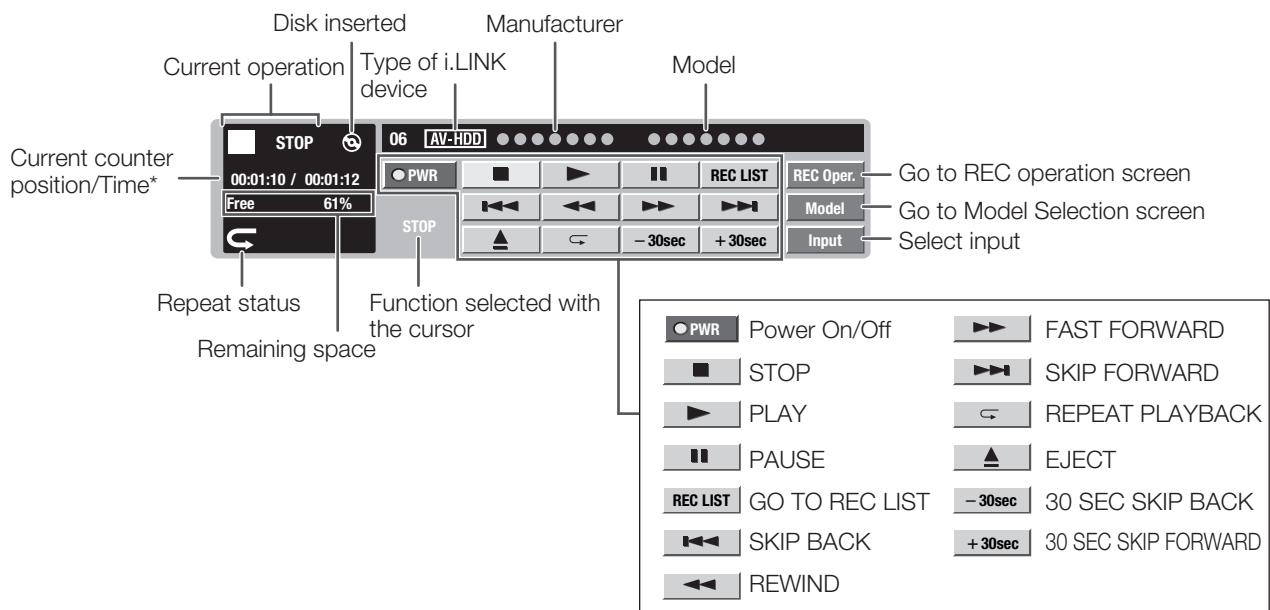

#### NOTE

- The “Input” button is used to select either i.LINK or other input.
- The EJECT button is displayed for Blu-ray Disc recorder only.

\* Time: If you commence playback before Time is displayed, Time will not be displayed during the playback.

## Using external equipment

### i.LINK control panel (HDV camcorder - Video mode)

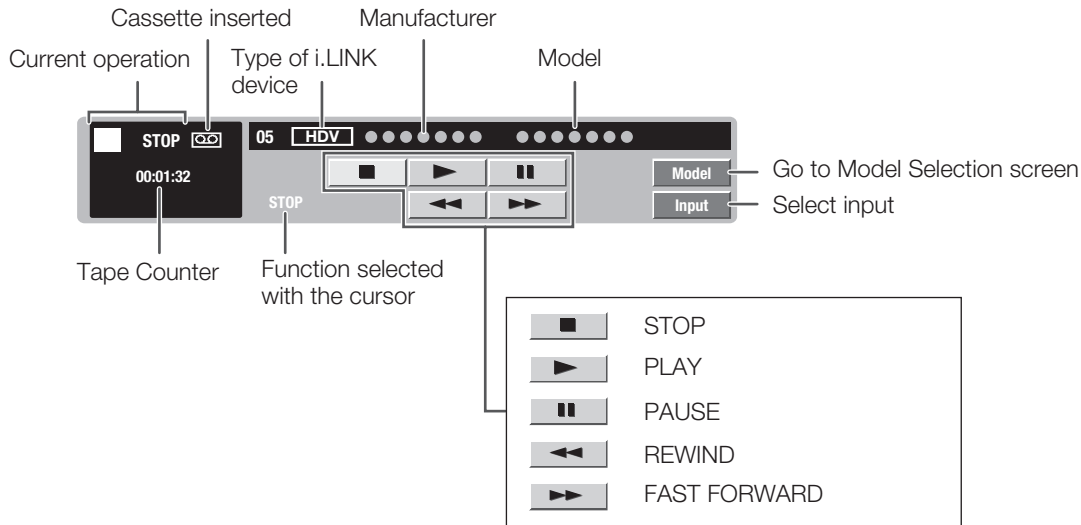

### i.LINK control panel (HDV camcorder - Camera mode)

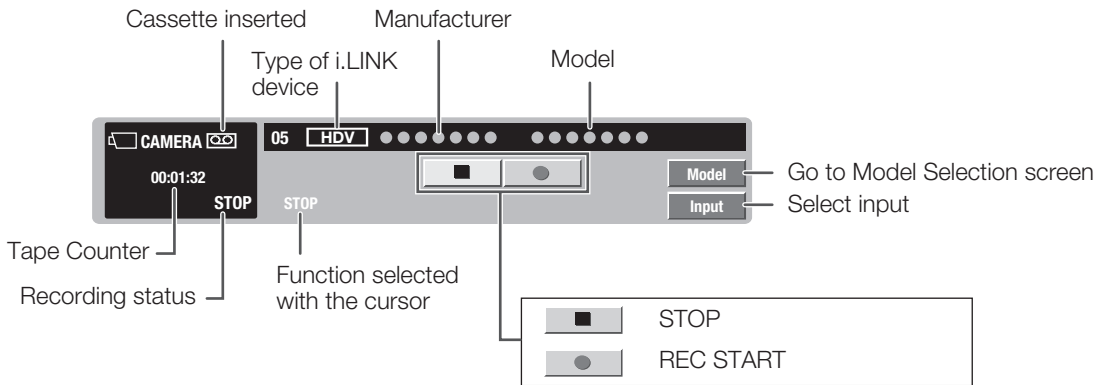

### i.LINK control panel (STB/TV)

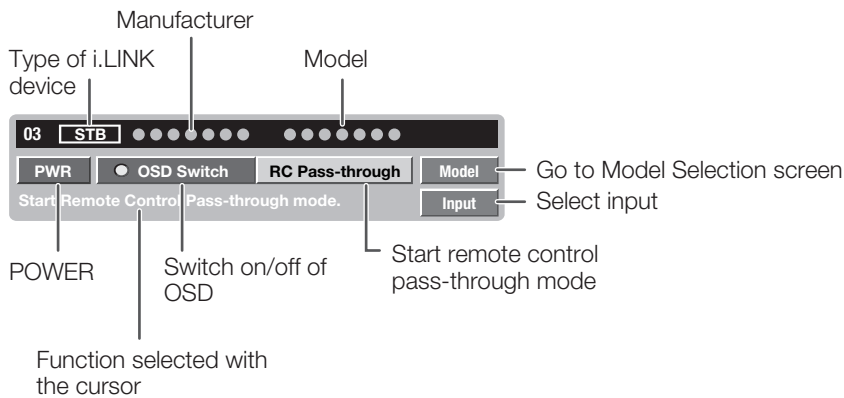

#### NOTE

- Depending on the STB or TV, the "OSD Switch" button and/or "RC Pass-through" button may not display.

## Using external equipment

---

### NOTE

- IEEE1394 is the IEEE's international standard.
- i.LINK and the i.LINK logo are registered trademarks of Sony Electronic, Inc.
- A copy protection technology is used on i.LINK devices that incorporate copyright protection. This technology has received the approval of the Digital Transmission Licensing Administrator (DTLA), an organization that administers copyright protection technologies. Some picture and sound data have restrictions on duplication. Such data cannot be digitally copied using the i.LINK. Some picture and sound data may not be able to be sent back and forth between an i.LINK device that has DTLA copyright protection technology and one that does not.

### **Notes on i.LINK connection of D-VHS deck/AV-HDD recorder/Blu-ray Disc recorder**

- The input signal can be switched from i.LINK to another input by moving the cursor to the "Input" button on the control panel and pressing **ENTER**, even while a connected i.LINK device is playing.
- This TV may not be able to operate some i.LINK devices using the control panel, or to display picture and/or sound input from some i.LINK devices.
- When the TV's control panel is used to record a program, what is recorded with the i.LINK device are the pictures and sound of the digital program that the TV is receiving.
- The i.LINK control panel cannot be used during timer recording.
- There may be some programs which i.LINK devices cannot record.
- With some i.LINK devices, the quality of the picture may be distorted during fast forwarding or rewinding.

### **Notes specifically on i.LINK connection of D-VHS deck**

- Depending on the D-VHS deck, this TV's i.LINK may not allow viewing of VHS and S-VHS tape or analog recorded D-VHS tape. In this case, connect the D-VHS deck's analog output with the TV's analog input, and switch the TV's input mode to external input.
- If a D-VHS deck is operated with the TV's control panel during timer recording, the recording may fail. Do not use the TV's control panel to operate the D-VHS deck during timer recording.
- To record the picture and sound of a digital program which the TV is receiving, use D-VHS tape. VHS or S-VHS tape will not record.

### **Notes specifically on i.LINK connection of AV-HDD recorder/Blu-ray Disc recorder**

- Depending on the AV-HDD recorder and/or Blu-ray Disc recorder, some functions, such as playback during recording, display of the recording list screen during recording, and so on, may not be able to be operated.
- Depending on the AV-HDD recorder and/or Blu-ray Disc recorder, playback may stop automatically when switching to another i.LINK device.
- If an AV-HDD recorder/Blu-ray Disc recorder is operated with the TV's control panel during timer recording, the recording may fail. Do not use the TV's control panel to operate the AV-HDD recorder/Blu-ray Disc recorder during timer recording.

### **Notes specifically on i.LINK connection of AV-HDD recorder**

- Depending on the AV-HDD recorder, it may be possible to change the recorder's operations mode (D-VHS mode, HDD recorder mode). When the operations mode is D-VHS mode, the HDD recorder is recognized as a D-VHS Deck.



## Using external equipment

### Automatic input switching to i.LINK

Input mode can be set to automatically switch to i.LINK when an i.LINK device connected to the TV is played.

**1** Press **MENU** to display the MENU screen.

**2** Press **◀/▶** to select “Digital Setup”.

**3** Press **▲/▼** to select “i.LINK Setup”, and then press **ENTER**.

**4** Press **▲/▼** to select “i.LINK Autoswitch”, and then press **ENTER**.

**5** Press **◀/▶** to select “Yes”, and then press **ENTER**.

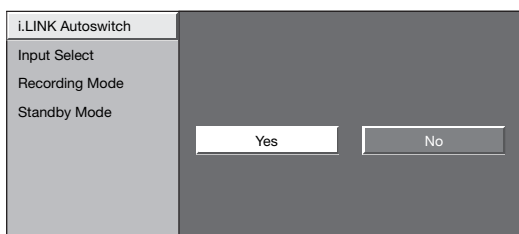

**6** Press **MENU** to exit.

### Recording digital programs with a D-VHS deck (i.LINK)

Before commencing this procedure, the steps in “i.LINK Setup” on pages 34 and 35 need to be completed beforehand.

Please also refer to the operation manual of the D-VHS deck to be used with this TV.

**1** Select a digital program to be recorded.

**2** Press **i.LINK** to display the i.LINK control panel.



**3** Press **▲/▼/◀/▶** to select “●”, and then press **ENTER**.

- Recording starts.
- Select “■” and press **ENTER** to stop recording.

#### NOTE

- Input mode cannot be switched to i.LINK during recording.
- When a D-VHS deck connected to the TV is under timer recording, the deck cannot be operated using the TV's control panel.
- When an analog signal is being received on the TV, you cannot use the i.LINK device to record.

## Using external equipment

### Recording digital programs with AV-HDD recorder/Blu-ray Disc recorder

Before commencing this procedure, the steps in “i.LINK Setup” on pages 34 and 35 need to be completed beforehand.

Please also refer to the operation manual of the AV-HDD recorder/Blu-ray Disc recorder to be used with this TV.

- 1 Select a digital program to be recorded.
- 2 Press **i.LINK** to display the i.LINK control panel.
- 3 Press **▲/▼/◀/▶** to select “REC Oper.”, and then press **ENTER**.
- 4 Press **▲/▼/◀/▶** to select “●”, and then press **ENTER**.
  - Recording starts.
  - Select “REC STOP” and press **ENTER** to stop recording.



#### NOTE

- Input mode cannot be switched to i.LINK during recording.
- When the input mode is i.LINK, you cannot operate recording.
- When an AV-HDD recorder/Blu-ray Disc recorder connected to the TV is under timer recording, the recorder cannot be operated using the TV's control panel.
- When an analog signal is being received on the TV, you cannot use the i.LINK device to record.

### Playing back using REC LIST (i.LINK)

You can display a list of the programs you have recorded on AV-HDD recorder and Blu-ray Disc.

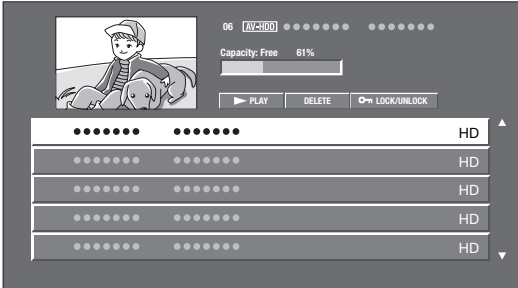
- 1 Press **i.LINK** to display the i.LINK control panel.
- 2 Press **▲/▼/◀/▶** to select “REC LIST”, and then press **ENTER** to display the REC LIST.
- 3 Press **▲/▼** to select the desired program, and then press **ENTER**.
 

The screenshot shows the REC LIST screen with a title bar '06 [AV-HDD]' and a 'Capacity: Free 61%' indicator. Below the title bar are buttons for 'PLAY', 'DELETE', and 'LOCK/UNLOCK'. A list of programs is shown, each with a progress bar and the label 'HD'. The first program has a small icon of a person riding a horse.
- 4 Press **◀/▶** to select “PLAY”, and then press **ENTER**.
- 5 Press **◀/▶** to select “From Top” or “From current position”, and then press **ENTER**.

Selected item	Description
From Top	Playback will start from the beginning of the selected program.
From current position	Playback will start from the point playback stopped last time.

#### NOTE

- A program in the REC LIST may be deleted by performing: Select the program → Press **ENTER** → Select “DELETE” on REC LIST → Press **ENTER** → Select “Delete” → Press **ENTER**
- A program in the REC LIST may be locked or unlocked by performing: Select the program → Press **ENTER** → Select “LOCK/UNLOCK” → Press **ENTER**
- Depending on the device connected, the audio and images of the program selected with the cursor may not be displayed in the small play screen.
- The program information displayed in the title (Program name, date and time, etc.) will be taken from the program information for the program broadcast at the time recording commenced.
- When recording several programs in succession, the program information displayed will be that of the first program recorded at the time recording originally commenced.
- When playing back content recorded on other devices, the program information in the title may not be displayed correctly in some cases.

## Using external equipment

### Capture and playback video with an HDV camcorder

You can enjoy video and sound from an HDV camcorder on the TV.

An HDV camcorder can send a “DV format” signal as well as an “HDV format” signal. The TV is only capable of playing back an “HDV format” signal.

#### NOTE

- Signals received on the TV from broadcasts or other external equipment cannot be recorded on an HDV camcorder.
- When the HDV camcorder is set to “DV compatible mode”, HDV camcorder cannot be chosen in the i.LINK device selection screen. (See page 36.) Please consult your HDV camcorder’s instruction manual for more information.
- You cannot turn on or off the HDV camcorder from the i.LINK control panel

#### About the input select button

- The i.LINK control panel input select button is used to select between output from the TV to i.LINK device and input from i.LINK device. (When the i.LINK device is selected on page 36, “output” will be selected.) When an i.LINK device is played back during i.LINK selection, i.LINK input will automatically be selected.
- When an HDV camcorder is connected to the TV and the camera’s mode is changed from video mode to camera mode, input from HDV camcorder is automatically selected.

#### About the capture button

- The capture button on the i.LINK control panel is for recording images and audio captured by the camera mode of the HDV camcorder.
- When viewing images on the TV from broadcasts or other equipment, the capture button has no effect.

### Playback video with an HDV camcorder

- 1 Connect an HDV camcorder to the TV.
- 2 Set the HDV camcorder to “video mode”.
  - When the HDV camcorder is set to “camera mode”, images from the camera cannot be viewed on the TV.
- 3 Press **i.LINK** to display the i.LINK control panel.

4

Press **▲/▼/◀/▶** to select “▶” on the i.LINK control panel, and then press **ENTER**.

- Playback starts.
- For special playback options during playback, select “▶▶”, “◀◀”, or “⏸” on the i.LINK control panel and then press **ENTER**.
- To stop playback, select “■” on the i.LINK control panel and then press **ENTER**.



#### NOTE

- The TV cannot playback signals recorded in “DV format”.
- When a tape containing both “HDV format” and “DV format” signals is used, the message “The TV cannot playback this signal. Please check the HDV device settings.” appears when the “DV format” signal is played.
- The TV cannot cue an HDV camcorder.

### Capture video with an HDV camcorder

1

Connect an HDV camcorder to the TV.

2

Set the HDV camcorder to “camera mode”.

- When the HDV camcorder is changed from “video mode” to “camera mode”, input from i.LINK is automatically selected.

3

Press **i.LINK** to display the i.LINK control panel.

4

Press **▲/▼/◀/▶** to select “●” on the i.LINK control panel, and then press **ENTER**.

- The HDV camcorder starts capturing video.
- To stop capturing video, select “■” and then press **ENTER**.



#### NOTE

- Some HDV camcorders include a “photo mode” for taking still pictures. When an HDV camcorder is in “photo mode”, the TV cannot control the camera via the i.LINK control panel. Please consult your HDV camcorder’s instruction manual for more information.
- Some HDV camcorders will automatically go into standby mode if they are left in camera mode for some time without being used to capture anything. This disconnects the i.LINK control. When this happens, you will not be able to operate the HDV camcorder via the i.LINK control panel, so please operate the HDV camcorder directly.
- Signals received on the TV from broadcasts or other external equipment cannot be recorded on an HDV camcorder.

## Using external equipment

### DTVLink

When the TV is connected to an i.LINK device such as a digital STB/digital TV via the i.LINK cable, you can view the On-Screen Display of the connected i.LINK devices on the TV if the device supports this function. DTVLink also allows you to control the connected i.LINK devices using the TV's remote control without displaying the i.LINK control panel.

### Remote Control Pass-through

You can control the connected i.LINK devices using the TV's remote control without displaying the i.LINK control panel.

- The remote control buttons that can be used with Remote Control Pass-through during the "Pass-through" mode are shown below.

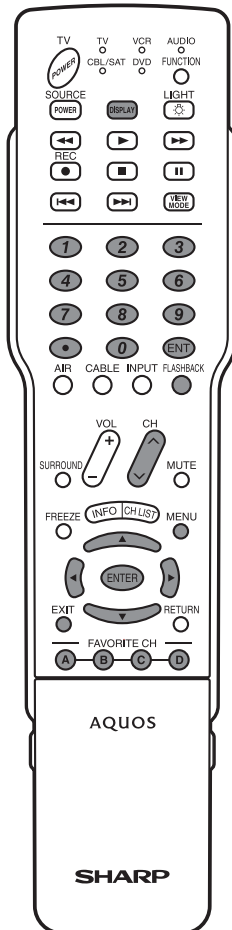

1

Press **i.LINK** to display the i.LINK control panel.

2

Press ◀/▶ to select "RC Pass-through", and then press **ENTER**.

- The message appears and the TV enters the RC Pass-through mode.
- "RC Pass-through" will be displayed on the TV screen for a few seconds when a designated button for controlling the i.LINK device is pressed.

### NOTE

- To cancel RC Pass-through, press **i.LINK** on the remote control.
- Depending on the device connected, RC Pass-through cannot be used.

### OSD Switch

You can view the On-Screen Display of the connected i.LINK devices on the TV.

1

Press **i.LINK** to display the i.LINK control panel.

2

Press ◀/▶ to select "OSD Switch", and then press **ENTER** to turn "OSD Switch" on or off.

- The "OSD Switch" status indicator turns green when the "OSD Switch" is on.
- The "OSD Switch" status indicator turns red when the "OSD Switch" is off.

The "OSD Switch" status indicator



### NOTE

- Depending on the device connected, the On-Screen Display of the connected i.LINK devices cannot be viewed on the TV.
- You cannot view the On-Screen Display of the connected device when the device is not connected with an i.LINK cable.
- You cannot view the On-Screen Display of the connected device when an analog signal is being received from the connected device.

# Useful adjustment settings

## Input Skip

This setting allows you to skip the HDMI/DVI Input on the Input Selection operation.

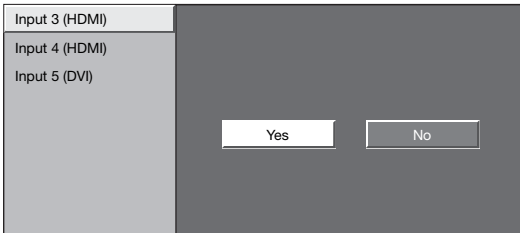
- 1 Press **MENU** and the MENU screen displays.
  - 2 Press ◀/▶ to select "Setup".
  - 3 Press ▲/▼ to select "Input Skip", and then press **ENTER**.
  - 4 Press ▲/▼ to select the Input (INPUT 3, INPUT 4 or INPUT 5) you wish to skip, and then press **ENTER**.
- 
- 5 Press ◀/▶ to select "Yes", and then press **ENTER**.
  - 6 Press **MENU** to exit.

## Standby Mode

Standby Mode may be set to either start the TV quickly from standby or conserve energy while on standby.

- 1 Press **MENU** and the MENU screen displays.
- 2 Press ◀/▶ to select "Setup".
- 3 Press ▲/▼ to select "Standby Mode", and then press **ENTER**.
- 4 Press ▲/▼ to select "Mode1" or "Mode2", and then press **ENTER**.

Selected item	Description
<b>Mode1</b>	Starting TV is quick from standby.
<b>Mode2</b>	Power consumption is small at the standby.

- 5 Press **MENU** to exit.

## Language setting

You can also select a language from the Setup menu. Select from among 3 languages: English, French and Spanish.

- 1 Press **MENU** and the MENU screen displays.
- 2 Press ◀/▶ to select "Setup".
- 3 Press ▲/▼ to select "Language", and then press **ENTER**.
- 4 Press ▲/▼ to select the desired language listed on the screen, and then press **ENTER**.
- 5 Press **MENU** to exit.

## Image position (AV input mode only)

For adjusting a picture's horizontal and vertical position.

- 1 Press **MENU** and the MENU screen displays.
- 2 Press ◀/▶ to select "Setup".
- 3 Press ▲/▼ to select "Position", and then press **ENTER**.
- 4 Press ▲/▼ to select "H-Pos." or "V-Pos.".

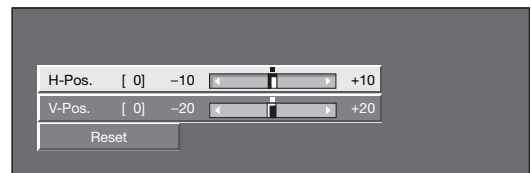

Selected item	Description
<b>H-Pos.</b>	Centers the image by moving it to the left or right.
<b>V-Pos.</b>	Centers the image by moving it up or down.

- 5 Press ◀/▶ to adjust the item to the desired position.
- 6 Press **MENU** to exit.

### NOTE

- For resetting adjustments to the factory preset values, press ▲/▼ to select "Reset", and then press **ENTER**.
- **Adjustments are stored separately according to input source.**

## Useful adjustment settings

### Auto Sync. adjustment (for Analog PC input mode only)

For automatically adjusting the PC image.

**1** Press **MENU** and the MENU screen displays.

**2** Press ◀/▶ to select “Setup”.

**3** Press ▲/▼ to select “Auto Sync.”, and then press **ENTER**.

**4** Press ◀/▶ to select “Yes”, and then press **ENTER**.

- Auto Sync. starts and “Now adjusting the image.” displays.

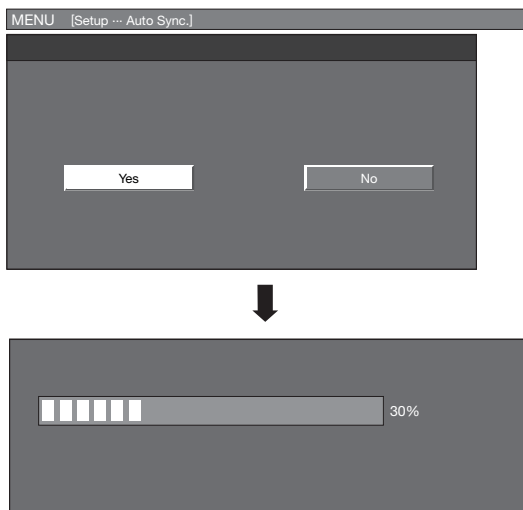

**5** Press **MENU** to exit.

#### NOTE

- When Auto Sync. is successful, “Completed” displays. If not, Auto Sync. failed.
- Auto Sync. may fail even if “Completed” displays.
- Auto Sync. may fail if the computer image has low resolution, has unclear (black) edges, or is moved while executing Auto Sync.
- Be sure to connect the PC to the TV and switch it on before starting Auto Sync.
- It is not necessary to use “Auto Sync.” when digital signal is being input, so it cannot be selected.

### Fine Sync. adjustment

Ordinarily you can easily adjust the picture as necessary to change image position using Auto Sync. In some cases, however, manual adjustment is needed to optimize the image.

**1** Press **MENU** and the MENU screen displays.

**2** Press ◀/▶ to select “Setup”.

**3** Press ▲/▼ to select “Fine Sync.”, and then press **ENTER**.

**4** Press ▲/▼ to select the specific adjustment item.

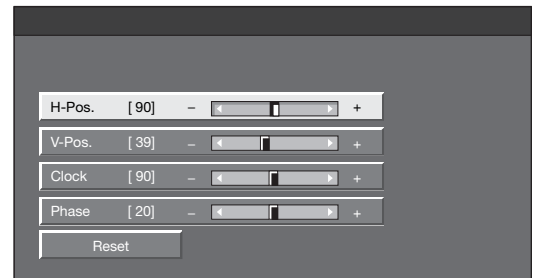

Selected item	Description
<b>H-Pos.</b>	Centers the image by moving it to the left or right.
<b>V-Pos.</b>	Centers the image by moving it up or down.
<b>Clock</b>	Adjust when the image flickers with vertical stripes.
<b>Phase</b>	Adjust when characters have low contrast or when the image flickers.

**5** Press ◀/▶ to adjust the item to your desired position.

**6** Press **MENU** to exit.

#### NOTE

- For resetting all Fine Sync. adjustment items to the factory preset values, press ▲/▼ to select “Reset”, and then press **ENTER**.
- It is not necessary to adjust the “Clock” or “Phase” when a digital signal is being input, so it cannot be selected.

## Useful adjustment settings

---

### Reset

If complex adjustments are made and the settings cannot be restored to normal, you can reset the settings to the factory preset values.

1

Press **MENU** and the MENU screen displays.

2

Press ◀/▶ to select "Setup".

3

Press ▲/▼ to select "Reset", and then press **ENTER**.

- If you already set the Secret No., input the 4-digit secret number here. See page 56 for setting a secret number.
- "Return to the factory preset values" displays on the screen.

4

Press ◀/▶ to select "Yes", and then press **ENTER**.

- "Now, TV will restart automatically. OK?" displays on the screen.

5

Press ◀/▶ to select "Yes", and then press **ENTER**.

- "Now initializing..." displays on the screen and blinks.
- After the reset has completed, the power shuts off and then comes back on. The screen will have returned to its original settings.

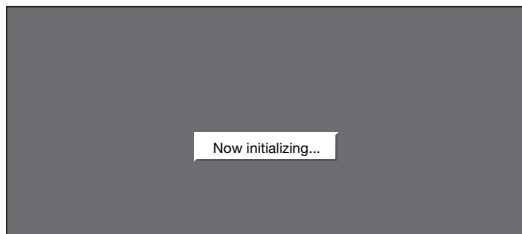

#### NOTE

- The AV MODE will be set to "DYNAMIC".
- The Channel Setup settings will not be changed.
- The Language settings will not be changed.
- The Secret number settings will not be changed.

## Useful adjustment settings

### Input Select

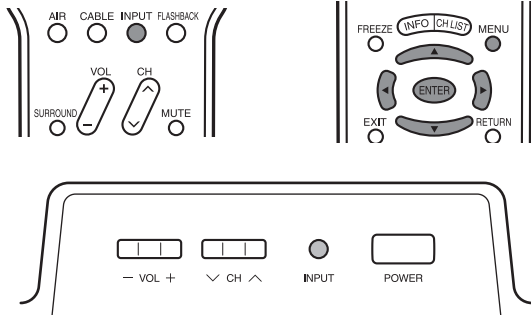

#### Selecting input source

Use this menu to select the input source.

- 1 Press **INPUT**.
  - A list of selectable sources appears.
- 2 Press **INPUT** again to select the input source.
  - An image from the selected source automatically displays.
  - You can also select the input source by pressing **▲/▼**.
  - If the corresponding input is not plugged in, you cannot change the input. Be sure to connect the equipment beforehand.

#### Selecting input signal type

For setting the signal type of external equipment connected to INPUT 1 terminals.

- 1 Press **MENU** and the MENU screen displays.
- 2 Press **◀/▶** to select "Option".
- 3 Press **▲/▼** to select "Input Select", and then press **ENTER**.
- 4 Press **▲/▼** to select the signal type you want to set, and then press **ENTER**.
  - If the selected signal type is incorrect, images are not displayed or displayed without any color.
- 5 Press **MENU** to exit.

#### NOTE

- If you set INPUT 1 to Auto, the TV will automatically select the input signal.
- Check the operation manual of the external equipment for the signal type.
- Setting INPUT 1 signal selection to "Auto" when other equipment is connected will result in the following connection priority.

INPUT 1
1. COMPONENT VIDEO
2. VIDEO

### DVI input signal setting

- 1 Press **INPUT** to select INPUT 5.

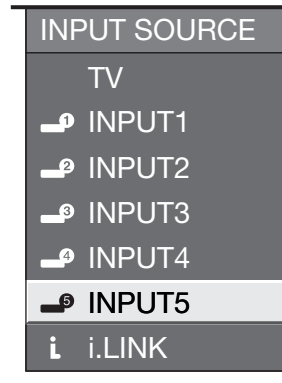

- 2 Press **MENU** and the MENU screen displays.

- 3 Press **◀/▶** to select "Option".

- 4 Press **▲/▼** to select "Input Select", and then press **ENTER**.

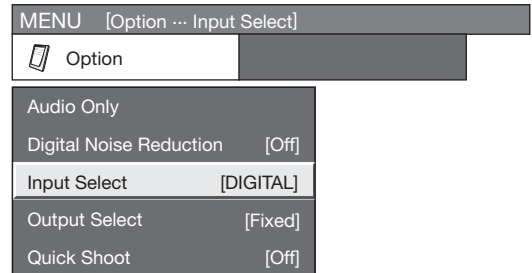

- 5 Press **▲/▼** to select the equipment connected to INPUT 5 terminal, and then press **ENTER**.

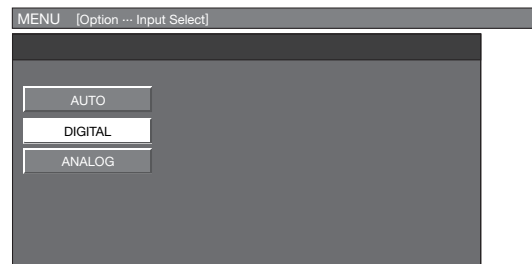

- 6 Press **MENU** to exit.



## Useful adjustment settings

### Input Label

Lets you set the input terminal displayed when using the INPUT SOURCE menu or channel display.

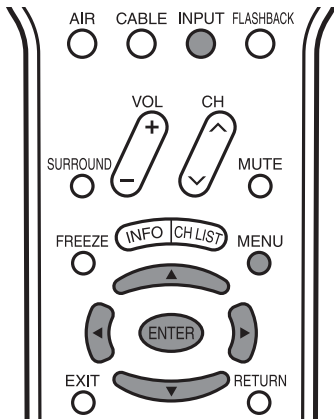

- 1 Press **INPUT** to select the desired input source.
- 2 Press **MENU** and the MENU screen displays.
- 3 Press **◀/▶** to select "Setup"
- 4 Press **▲/▼** to select "Input Label", and then press **ENTER**.
- 5 Press **▲/▼/◀/▶** to select the new name for the input mode, and then press **ENTER**.



(Example)

- 6 Press **MENU** to exit.

#### NOTE

- You cannot change labels if the INPUT SOURCE is TV or i.LINK.

### Picture Flip

You can set the orientation of the picture.

- 1 Press **MENU** and the MENU screen displays.
- 2 Press **◀/▶** to select "Setup".
- 3 Press **▲/▼** to select "Picture Flip", and then press **ENTER**.
- 4 Press **▲/▼** to select the desired mode, and then press **ENTER**.

[Standard]: normal image

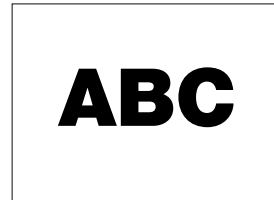

[Mirror]: mirror image



[Upside Down]: upside down image



[Rotate]: rotated image



- 5 Press **MENU** to exit.

## Useful adjustment settings

### View Mode for 4:3 Programs

1

Press **VIEW MODE**.

- The View Mode menu displays.
- The menu lists the View Mode options selectable for the type of video signal currently being received.

2

Press **VIEW MODE** or **▲/▼** while the View Mode menu is still on the screen.

- You can sequentially select a View Mode that has its own aspect ratio.

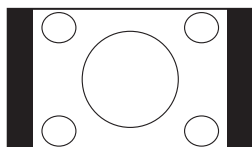
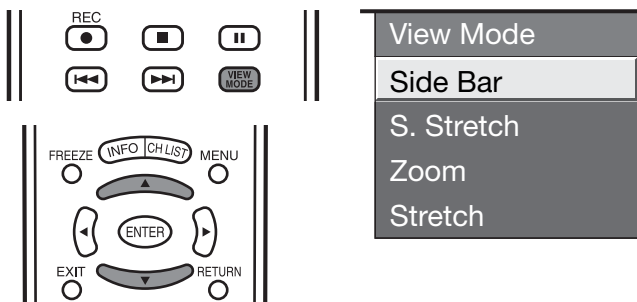

#### Side Bar:

Suitable for viewing conventional 4:3 programs in their normal format.

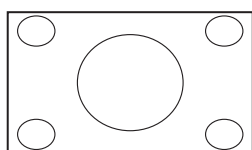

#### S.Stretch (Smart stretch):

Suitable for stretching 4:3 programs to fill the screen.

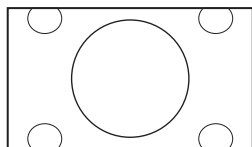

#### Zoom:

Suitable for viewing wide-screen 2.35:1 anamorphic DVDs in full screen.

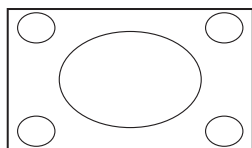

#### Stretch:

This mode is useful for 1.78:1 DVDs. When viewing 1.85:1 DVDs, stretch mode will still show very thin black bands at the top and bottom of the screen.

### View Mode for HD Programs

The following modes are available for HD programs.

#### Stretch:

Suitable for viewing wide-screen 1.78:1 aspect ratio program, stretch mode will still show very thin black bands at the top and bottom of the screen.

#### Dot by Dot (1080i/p only):

Detects the resolution of the signal and displays an image with the same number of pixels on the screen. When a 720p signal is being input, the image will be delivered in full screen.

#### S.Stretch (Smart stretch):

Suitable for stretching 4:3 programs to fill the screen.

#### Zoom:

Suitable for viewing wide-screen 2.35:1 aspect-ratio programs in full screen.

#### NOTE

- When using Dot by Dot, it is possible to see noise or bars around different outer portions of the screen. Please change view mode to correct this.

## Useful adjustment settings

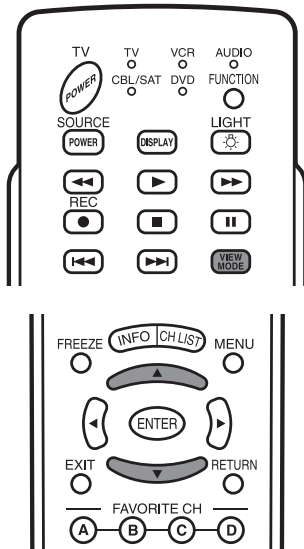

### EXAMPLE

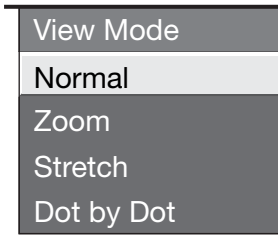

## View Mode (for PC input mode)

You can select the screen size.

### NOTE

- Connect the PC before making adjustments. (See page 32.)
- Selectable screen size may vary with input signal type.

1

Press **VIEW MODE**.





- The View Mode menu displays.

2

Press **VIEW MODE** or ▲/▼ to select a desired item on the menu.

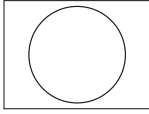
### EXAMPLE

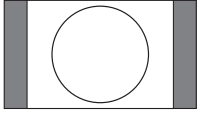
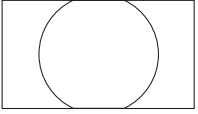
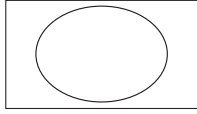
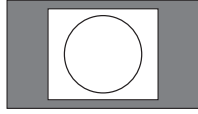
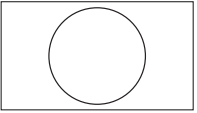
Screen size images.

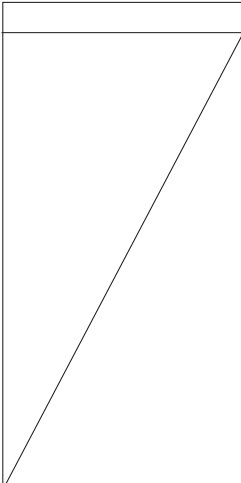
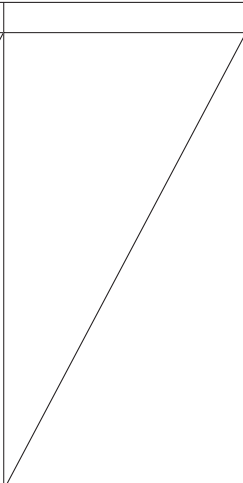
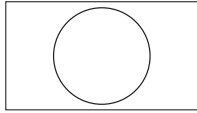
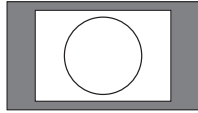
<p><b>Input signal</b></p>  <p><b>4:3</b></p>		<p><b>Normal</b></p>  <p>Keeps the original aspect ratio in a full screen display.</p>	<p><b>Zoom</b></p>  <p>For viewing wide-screen programs. The top and bottom of the image is cropped.</p>	<p><b>Stretch</b></p>  <p>An image fully fills the screen.</p>	<p><b>Dot by Dot</b></p>  <p>Detects the resolution of the signal and displays an image with the same number of pixels on the screen.</p>
<p><b>Input signal</b></p>  <p><b>16:9</b></p>				<p><b>Stretch</b></p>  <p>An image fully fills the screen.</p>	<p><b>Dot by Dot</b></p>  <p>Detects the resolution of the signal and displays an image with the same number of pixels on the screen.</p>

## Useful adjustment settings

### AV MODE

AV MODE gives you 7 viewing options to choose from to best match the surrounding environment of the TV, which can vary due to factors like room brightness, type of program watched or the type of image input from external equipment.

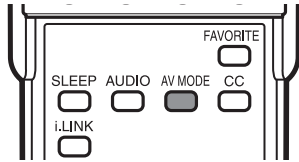

- 1 Press **AV MODE**.
  - Current AV MODE displays.

- 2 Press **AV MODE** again before the mode displayed on the screen disappears.
  - The mode changes as shown below.

#### Mode selection for TV, INPUT 1 to 5 and i.LINK terminals (Example)

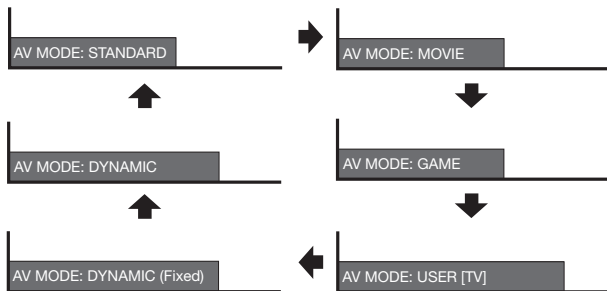

#### Mode selection for the PC terminal (Example)

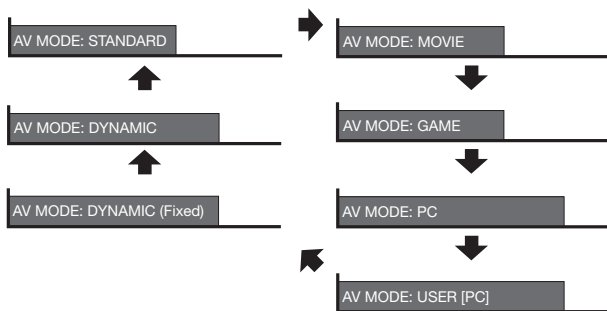

Selected item	Description
<b>STANDARD</b>	For a highly defined image in a normal lighting
<b>MOVIE</b>	For a movie
<b>GAME</b>	Lowers image brightness for easier viewing
<b>USER</b>	Allows the user to customize settings as desired. You can set the mode for each input source.
<b>DYNAMIC (Fixed)</b>	Changes the image and sound settings to the factory preset values. No adjustments are allowed.
<b>DYNAMIC</b>	For a clear-cut image emphasizing high contrast, useful for sports viewing
<b>PC</b>	For PC mode. (Only available when the input is from a PC.)

#### NOTE

- You can select a different AV MODE item for each input mode. (For example, select STANDARD for TV input and DYNAMIC for VIDEO input.)

### Input Signal (for PC input mode)

Some input signals may have to be registered manually to display properly.

The pair of input signals (resolutions) in the list below are not distinguishable when received. In such case, you have to set the correct signal manually. After setting once, it will display when the same signal (resolution) is input again.

1024 × 768	1360 × 768
------------	------------

#### NOTE

- You can only select the “Input Signal” on the Setup menu when receiving one of the 2 input signals listed above.

- 1 Press **MENU** and the MENU screen displays.
- 2 Press **◀/▶** to select “Setup”.
- 3 Press **▲/▼** to select “Input Signal”, and then press **ENTER**.
- 4 Press **▲/▼** to select the desired input signal on the display.
- 5 Press **MENU** to exit.

## Useful adjustment settings

### Digital Noise Reduction

Produces a clearer video image.

**1** Press **MENU** and the MENU screen displays.

**2** Press ◀/▶ to select “Option”.

**3** Press ▲/▼ to select “Digital Noise Reduction”, and then press **ENTER**.

**4** Press ▲/▼ to select the desired level, and then press **ENTER**.



**5** Press **MENU** to exit.

### Audio Only

When listening to music from a music program, you can set the screen off and enjoy audio only.

**1** Repeat steps 1 and 2 in **Digital Noise Reduction**.

**2** Press ▲/▼ to select “Audio Only”, and then press **ENTER**.

**3** Press ◀/▶ to select “On”, and then press **ENTER**.

Selected item	Description
On	Audio is output without screen image.
Off	Both screen images and audio are output.

#### NOTE

- The screen image will return to normal when a button (except those for audio adjustment, such as **VOL**, **MUTE**, **SURROUND**, **AUDIO**) is pressed.

### Output Select

Allows you to select what controls the audio output.

**1** Press **MENU** and the MENU screen displays.

**2** Press ◀/▶ to select “Option”.

**3** Press ▲/▼ to select “Output Select”, and then press **ENTER**.

**4** Press ◀/▶ to select “Fixed” or “Variable”, and then press **ENTER**.

Selected item	Description
<b>Fixed</b>	<ul style="list-style-type: none"> <li>Sound via speaker is adjusted with <b>VOL +/-</b> on the remote control unit or <b>VOL -/+</b> on the TV.</li> <li>Sound via the AUDIO OUTPUT terminal is not adjustable and outputs at a consistent level.</li> </ul>
<b>Variable</b>	<ul style="list-style-type: none"> <li>Sound via the AUDIO OUTPUT terminal is adjusted with <b>VOL +/-</b> on the remote control unit or <b>VOL -/+</b> on the TV.</li> <li>Sound via speaker is muted.</li> </ul>

**5** Press **MENU** to exit.

### Quick Shoot

Use Quick Shoot operation to view fast-action video more clearly.

**1** Repeat steps 1 and 2 in **Output Select**.

**2** Press ▲/▼ to select “Quick Shoot”, and then press **ENTER**.

**3** Press ◀/▶ to select “On”, and then press **ENTER**.

**4** Press **MENU** to exit.

#### NOTE

- Quick Shoot may cause image noise. If this occurs turn the function “Off”.

## Useful adjustment settings

### Color System

Select the optimum color system to receive. (Auto, NTSC, PAL-M, PAL-N)

- 1 Press **MENU** and the MENU screen displays.
- 2 Press **◀/▶** to select "Option".
- 3 Press **▲/▼** to select "Color System", and then press **ENTER**.
- 4 Press **▲/▼** to select the video signal system compatible with your equipment, and then press **ENTER**.
- 5 Press **MENU** to exit.

#### NOTE

- "Color System" can only be set for the INPUT 1 VIDEO and for INPUT 2.

### Program Title Display

Select the CH display when changing channels for digital broadcasting.

- 1 Press **MENU** and the MENU screen displays.
- 2 Press **◀/▶** to select "Option".
- 3 Press **▲/▼** to select "Program Title Display", and then press **ENTER**.
- 4 Press **◀/▶** to select "Yes" or "No", and then press **ENTER**.

Selected item	Description
Yes	"Program Info." displays
No	"Program Info." does not display

- 5 Press **MENU** to exit.

### Sleep Timer

Allows you to set a time when the TV automatically switches to standby.

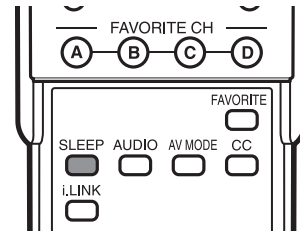

- 1 Press **SLEEP**.
  - The remaining time displays when the sleep timer has been set.

Sleep Timer: Remaining 30

- 2 Each time you press **SLEEP**, the remaining time switches as shown below.
  - When set, the time automatically starts counting down.
  - If you want to adjust the sleep timer, you can press **SLEEP** twice then change the time setting.
  - Five minutes before the time expires, the remaining time displays every minute.

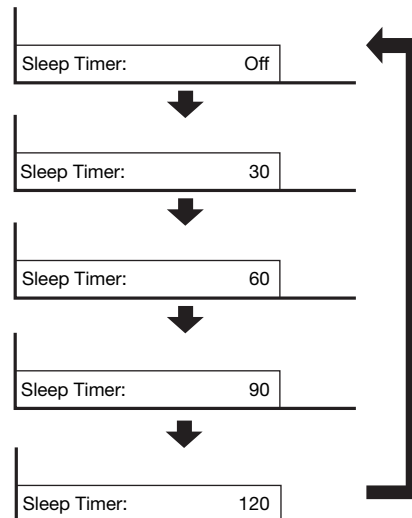

#### NOTE

- Select "Off" by pressing **SLEEP** to cancel the sleep timer.
- The TV will enter the standby mode when the remaining time reaches zero.

## Useful adjustment settings

### Closed Captions and Digital Closed Captions

Your TV is equipped with an internal Closed Caption decoder. It allows you to view conversations, narration and sound effects as subtitles on your TV. Closed Captions are available on some TV programs and on some VHS home video tapes at the discretion of the program provider.

Digital Closed Caption service is a new caption service available only on digital TV programs (also at the discretion of the service provider). It is a more flexible system than the original Closed Caption system, because it allows for a variety of caption sizes and font styles. When the Digital Closed Caption service is in use, it will be indicated by the appearance of a 3-letter abbreviation that also indicates the language of the Digital Closed Captions: ENG (English), SPA (Spanish), FRA (French) or other language codes.

Not all programs and VHS videotapes offer closed captions. Please look for the “**CC**” symbol to ensure that captions will be shown.

In the Closed Caption system, there can be more than one caption service provided. Each is identified by its own number. The “CC1” and “CC2” services display subtitles of TV programs superimposed over the program's picture.

In the Closed Caption system, the “Text1” or “Text2” services display text that is unrelated to the program being viewed (e.g., weather or news). These services are also superimposed over the program currently being viewed.

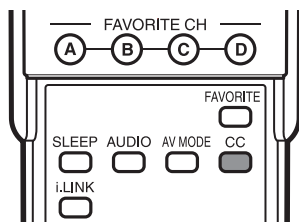

1

Press **CC**.

- This will present the Closed Caption information display.

2

Press **CC** while the Closed Caption information is still on the screen.

- Press repeatedly until you select the desired closed caption service.

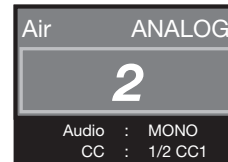

Closed Caption information

- Depending on the number of caption services in the signal being received, you will see information such as 1/2 or 1/4 displayed. 1/2 means “the first of two services”.

Example:

If a program has three services (Digital CC(ENG), CC1 and Text1), the closed caption display will toggle in this sequence:

1/3 ENG → 2/3 CC1 → 3/3 Text1 → OFF

- The CC button keeps a record of the last service selected in its memory. If the last closed caption mode (e.g. 1/3ENG) you selected is not available for the next program, or on another channel, the closed caption service that is available is automatically selected, and this service appears in parentheses, e.g. “1/3(CC1)”. Closed Caption services that appear in parentheses will not be stored in the CC button's memory as your last selected service. Only services that you have selected with the CC button are stored.

#### Examples:

In a case where there are two closed caption services provided, (for instance, Digital CC(ENG) and CC1), and Digital CC(ENG) is displayed as your current selection, if Digital CC(ENG) is not broadcast for the next program, the other closed caption service, CC1, will be displayed in parentheses.

A closed caption service appears in parentheses because the service you selected is not available and a different service is displayed on your screen. “1/1(CC1)” is displayed instead of “1/2/ENG”.

#### NOTE

- See page 55 for detailed closed caption settings.
- When the program contains no closed caption, “--” displays in the closed caption information.
- If the language code, e.g. “ENG”, is not found on Digital TV programs, “--” will be shown.
- Four kinds of closed caption service (CC1, CC2, Text1, Text2) are potentially available, but a broadcast may contain none or only some of these services at the discretion of the program provider.

## Useful adjustment settings

### Caption Setup

This function allows you to adjust the closed caption screen appearance to suit your preference.

**1** Press **MENU** and the MENU screen displays.

**2** Press ◀/▶ to select “Option”.

**3** Press ▲/▼ to select “Caption Setup”, and then press **ENTER**.

**4** Press ▲/▼ to select a specific adjustment item.

- You can adjust 7 items here; they are,

- ① “Caption Size”,
- ② “Font Style”,
- ③ “Foreground Color”,
- ④ “Foreground Opacity”,
- ⑤ “Background Color”,
- ⑥ “Background Opacity” and
- ⑦ “Character Edge”.

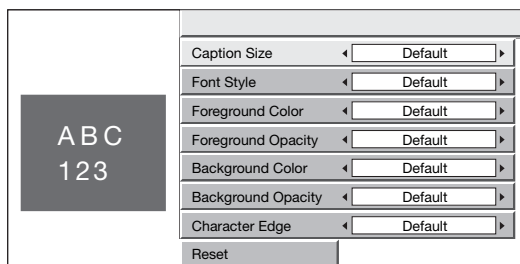

**5** Press ◀/▶ to select the desired parameter.

**6** Press **MENU** to exit.

### NOTE

- For resetting adjustments to the factory preset values, press ▲/▼ to select “Reset”, and then press **ENTER**.
- The default value depends on the broadcasting station.

### Selectable items available for “Font Style”.

Selected item	Description
<b>Default</b>	The font specified by broadcasting station or default font.
<b>Type 0</b>	Proportional font used in the MENU screen.
<b>Type 1</b>	Monospaced with serifs.
<b>Type 2</b>	Proportionally spaced with serifs.
<b>Type 3</b>	Monospaced without serifs.
<b>Type 4</b>	Proportionally spaced without serifs.
<b>Type 5</b>	Casual font type.
<b>Type 6</b>	Cursive font type.
<b>Type 7</b>	Small capitals.



## Useful adjustment settings

### Secret number setting for parental control (AV input mode only)

Allows you to use a secret number to protect certain settings from being accidentally changed.

#### IMPORTANT:

Three conditions must be met to enable the V-Chip (see pages 56 to 61):

- ① Secret No. is registered.
- ② V-Chip/V-Chip (DTV Only) settings have been made.
- ③ "Status" is set to "On".

#### Setting a secret number

**1** Press **MENU** and the MENU screen displays.

**2** Press **◀/▶** to select "Setup".

**3** Press **▲/▼** to select "Parental CTRL", and then press **ENTER**.

**4** Press **▲/▼** to select "Secret No.", and then press **ENTER**.

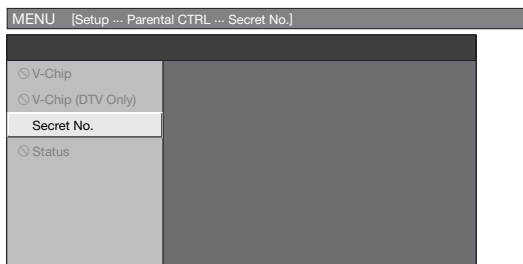

**5** Select "New Secret No.", and then press **ENTER**.  
Input the new 4-digit secret number by using **0-9**.

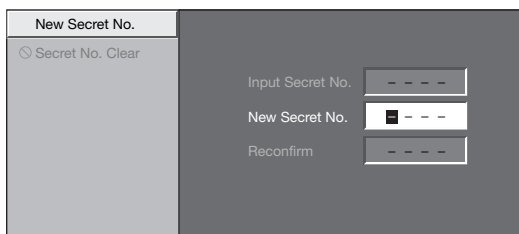

**6** Input the same 4-digit number on the "Reconfirm" screen as in step 5 to confirm.

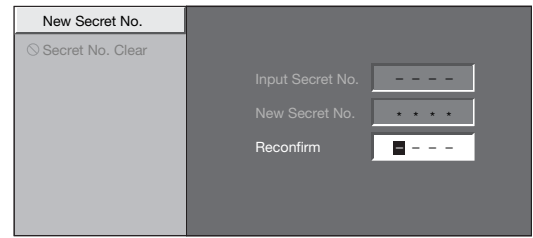

**7** Press **RETURN** to start configuring the V-Chip settings. (See pages 59 and 61 for details.)

**8** Press **MENU** to exit.

#### Setting parental control status

Used to enable or disable the parental control function.

**1** Repeat steps 1 to 3 in **Setting a secret number**.

- The secret number setting menu displays.

**2** Input the 4-digit secret number by using **0-9**.

**3** Press **▲/▼** to select "Status", and then press **ENTER**.

**4** Press **◀/▶** to select "On" or "Off", and then press **ENTER**.

- Select "On" to enable and "Off" to disable Parental CTRL.

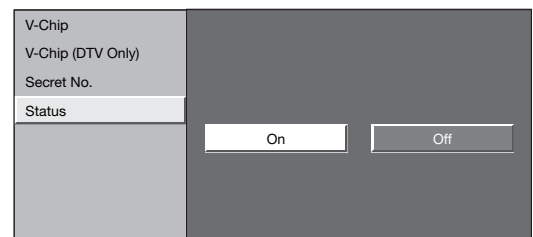

**5** Press **MENU** to exit.

#### NOTE

- You can skip step 1 and 2 above while in the Parental CTRL screen.
- The "V-Chip (DTV Only)" will only be selectable when a new rating system can be downloaded via digital broadcasting in the U.S.

## Useful adjustment settings

### Changing the secret number

Allows you to change your current secret number.

- 1 Repeat steps 1 to 3 in **Setting a secret number**.
  - The secret number setting menu displays.
- 2 Input the 4-digit secret number by using **0–9**.
- 3 Press **▲/▼** to select “Secret No.”, and then press **ENTER**.
- 4 Press **▲/▼** to select “New Secret No.”, and then press **ENTER**.
- 5 Input the old 4-digit secret number by using **0–9**.

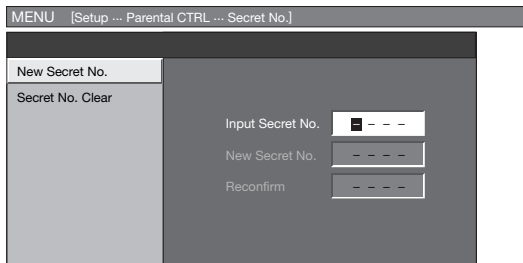

- 6 Input the new 4-digit secret number by using **0–9**.

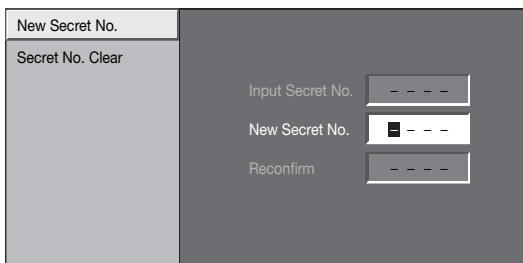

- 7 Input the same 4-digit number on the “Reconfirm” screen as in step 6 to confirm.

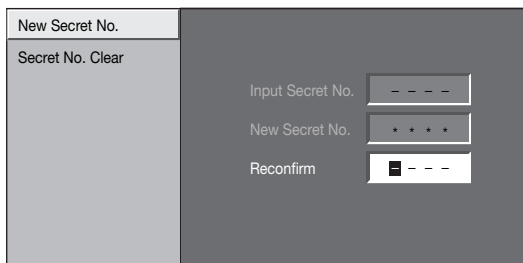

- 8 Press **MENU** to exit.

### Clearing the secret number

Allows you to clear your secret number.

- 1 Repeat steps 1 to 3 in **Setting a secret number**.
  - The secret number setting menu displays.
- 2 Input the 4-digit secret number by using **0–9**.
- 3 Press **▲/▼** to select “Secret No.”, and then press **ENTER**.
- 4 Press **▲/▼** to select “Secret No. Clear”, and then press **ENTER**.
- 5 Press **◀/▶** to select “Yes”, and then press **ENTER**.
  - Your secret number is cleared.

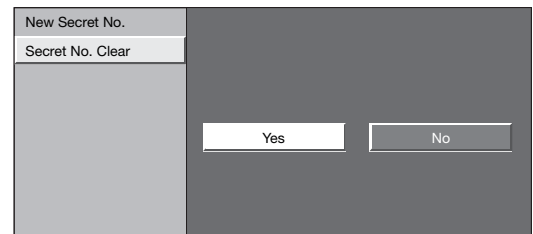

- 6 Press **MENU** to exit.

#### NOTE

- See page 56 for re-registering a new secret number after being cleared.
- **As a precautionary measure, make a note of your secret number and keep it in a familiar place.**
- If the secret number is cleared, the Status setting automatically sets to “Off”. “V-Chip” and “Status” will not be selectable from the menu.

## Useful adjustment settings

### Parental control (setting V-CHIP level)

V-CHIP is an electronic filtering device built into your TV. This tool gives parents a great degree of control over broadcasts accessed by their children. It allows parents to select programs judged suitable for child viewing while blocking ones judged not suitable. It does so automatically once you activate the V-CHIP feature in your TV.

**“V-Chip” and “Status” will not be selectable from the menu if you do not first configure your secret number.** (See page 56 for Secret number setting for parental control.)

- The U.S. has two rating systems for viewing content: TV Parental Guidelines and movie ratings.
- The TV Parental Guidelines work in conjunction with the V-CHIP to help parents screen out inappropriate television shows from their children.
- Movie ratings are used for original movies rated by the Motion Picture Association of America (MPAA) as watched on cable TV and not edited for television. The V-CHIP can also be set to block MPAA-rated movies.

### Voluntary movie rating system (MPAA)

Rating		Description
Age	G	General audiences. All ages admitted.
	PG	Parental guidance suggested. Some material may not be suitable for children.
	PG-13	Parents strongly cautioned. Some material may be inappropriate for children under 13.
	R	Restricted. Under 17 requires accompanying parent or adult guardian (age varies in some jurisdictions).
	NC-17	No one 17 and under admitted.
	X	X is an older rating that is unified with NC-17 but may be encoded in the data of older movies.

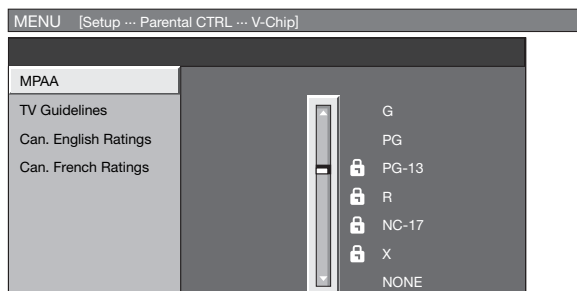

#### EXAMPLE

- If you select “PG-13”, this will automatically block the higher ratings “R”, “NC-17” and “X”.

#### NOTE

- Voluntary movie rating system only uses an age-based rating.

### TV Parental Guidelines

Rating		Content				
		FV (Fantasy violence)	V (Violence)	S (Sexual situation)	L (Adult language)	D (Sexually suggestive dialog)
Suggested age	TV-Y (All children)					
	TV-Y7 (Directed to older children)	X				
	TV-G (General audience)					
	TV-PG (Parental Guidance suggested)		X	X	X	X
	TV-14 (Parents strongly cautioned)		X	X	X	X
	TV-MA (Mature audience only)		X	X	X	

X: Content rating can be set.

## Useful adjustment settings

### Voluntary movie rating system (MPAA)

**1** Press **MENU** and the MENU screen displays.

**2** Press **◀/▶** to select "Setup".

**3** Press **▲/▼** to select "Parental CTRL", and then press **ENTER**.

- The secret number setting menu displays only when "Secret No." is set. (See page 56.)
- "V-Chip" and "Status" will not be selectable from the menu if you do not first configure your secret number. (See page 56.)

**4** Input the 4-digit secret number by using **0-9**.

**5** Press **▲/▼** to select "V-Chip", and then press **ENTER**.

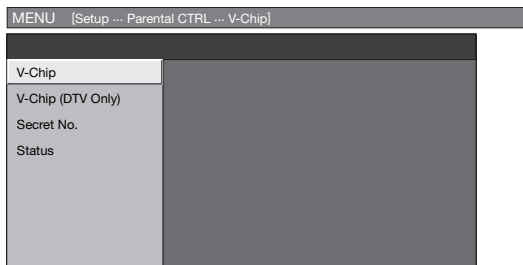

**6** Press **▲/▼** to select "MPAA", and then press **ENTER**.

**7** Press **▲/▼** to adjust the item to your desired position. "🔒" indicates the item is blocked. Press **RETURN**.

- The setting automatically enters "Block" for any ratings below your selection.
- If Status is not set to "On", the configuration settings will not work. (See page 56.)

#### Example

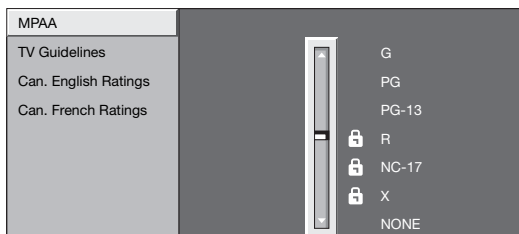

**8** Press **MENU** to exit.

### TV Parental Guidelines (TV Guidelines)

**1** Repeat steps 1 to 5 in **Voluntary movie rating system (MPAA)**.

**2** Press **▲/▼** to select "TV Guidelines", and then press **ENTER**.

**3** Press **▲/▼** to adjust the item to your desired position. "🔒" indicates the item is blocked.

- The setting automatically enters "Block" for any ratings below your selection.

#### Example

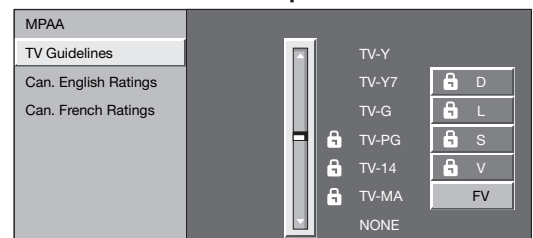

When setting an individual content-based rating item, do as follows:

- ① Press **▶** or **ENTER** to access blocked content items from the currently selected age-based rating item.
- ② Press **▲/▼** to select an individual item, and then press **ENTER** to unblock it ("🔒" is removed). Repeat the same steps for the other items.
- ③ Press **◀** or **RETURN** to register after all individual content rating items are set.

#### Example

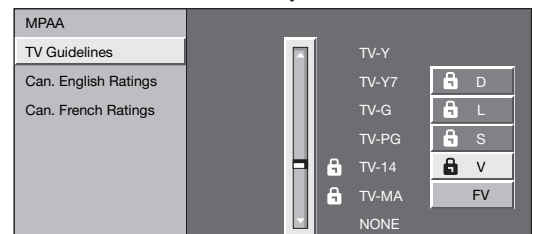

- If Status is not set to "On" the configuration settings will not work. (See page 56.)

**4** Press **MENU** to exit.

## Useful adjustment settings

### Canadian Rating Systems

- The TV rating systems in Canada are based on the Canadian Radio-Television and Telecommunications Commission (CRTC) policy on violence in television programming.
- While violence is the most important content element to be rated, the structure developed takes into consideration other program content like language, nudity, sexuality and mature themes.
- When setting the V-CHIP on the Canadian system you can choose either the Canadian English ratings or the Canadian French ratings.

### Canadian English ratings

Rating		Description
Age	E	Exempt: Includes news, sports, documentaries and other information programming; talk shows, music videos, and variety programming.
	C	Children: Intended for younger children under the age of 8 years. Pays careful attention to themes that could threaten their sense of security and well-being.
	C8+	Children over 8 years old: Contains no portrayal of violence as the preferred, acceptable, or only way to resolve conflict; nor encourage children to imitate dangerous acts which they may see on the screen.
	G	General: Considered acceptable for all age groups. Appropriate viewing for the entire family, contains very little violence, physical, verbal or emotional.
	PG	Parental Guidance: Intended for a general audience, but may not be suitable for younger children (under the age of 8) because it could contain controversial themes or issues.
	14+	Over 14 Years: Could contain themes where violence is one of the dominant elements of the storyline, but it must be integral to the development of plot or character. Language usage could be profane and nudity present within the context of the theme.
	18+	Adults: Intended for viewers 18 years and older and might contain depictions of violence, which while related to the development of plot, character or themes, are intended for adult viewing. Could contain graphic language and portrayals of sex and nudity.

### Canadian French ratings

Rating		Description
Age	E	Exempt programming.
	G	General: All ages and children, contains minimal direct violence, but may be integrated into the plot in a humorous or unrealistic manner.
	8ans+	General but inadvisable for young children: May be viewed by a wide public audience, but could contain scenes disturbing to children under 8 who cannot distinguish between imaginary and real situations. Recommended for viewing with parent.
	13ans+	Over 13 years: Could contain scenes of frequent violent scenes and therefore recommended for viewing with parent.
	16ans+	Over 16 years: Could contain frequent violent scenes and intense violence.
	18ans+	Over 18 years: Only for adult viewing. Could contain frequent violent scenes and extreme violence.

## Useful adjustment settings

### Canadian English ratings

- 1 Press **MENU** and the MENU screen displays.
- 2 Press **◀▶** to select "Setup".
- 3 Press **▲/▼** to select "Parental CTRL", and then press **ENTER**.
  - Secret number setting menu displays only when "Secret No." is set. (See page 56.)
  - "V-Chip" and "Status" will not be selectable from the menu if you do not first configure your secret number. (See page 56.)
- 4 Input the 4-digit secret number by using **0-9**.

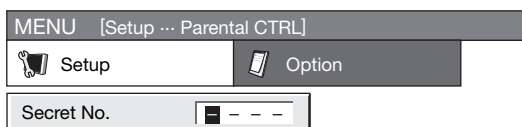

- 5 Press **▲/▼** to select "V-Chip", and then press **ENTER**.



- 6 Press **▲/▼** to select "Can. English Ratings", and then press **ENTER**.

- 7 Press **▲/▼** to adjust the item to your desired position. "🔒" indicates the item is blocked.
  - The setting automatically enters "Block" for any ratings below your selection.
  - If Status is not set to "On" the configuration settings will not work. (See page 56.)

#### Example

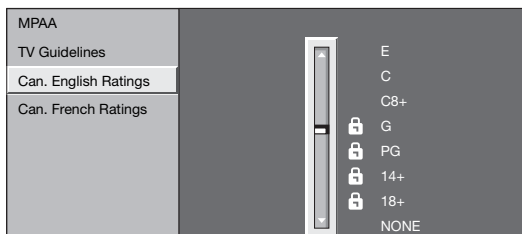

- 8 Press **MENU** to exit.

### Canadian French ratings

- 1 Repeat steps 1 to 5 in **Canadian English ratings**.
- 2 Press **▲/▼** to select "Can. French Ratings", and then press **ENTER**.
- 3 Press **▲/▼** to adjust the item to your desired position. "🔒" indicates the item is blocked.
  - The setting automatically enters "Block" for any ratings below your selection.
  - If Status is not set to "On" the configuration settings will not work. (See page 56.)

#### Example

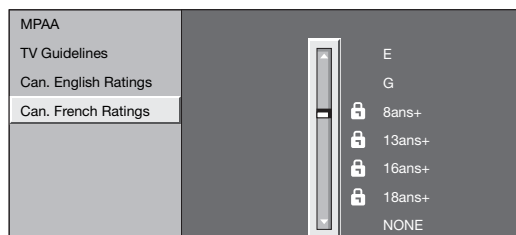

- 4 Press **MENU** to exit.

## How to temporarily release the V-CHIP BLOCK

When the V-CHIP BLOCK is working and censors a broadcast, "V-CHIP HAS BEEN ACTIVATED." displays.

- 1 Press **ENTER** while the V-CHIP is working and then the secret number setting menu displays.
- 2 Input the 4-digit secret number by using **0-9**. At this time V-CHIP BLOCK temporarily releases.

## Reactivating the temporarily released V-CHIP BLOCK

You can reactivate the temporarily released V-CHIP BLOCK as shown below.

#### Method 1:

Select "Status" setting from the Parental CTRL menu to reactivate BLOCK. (See page 56.)

#### Method 2:

Select "V-Chip" setting ("MPAA", "TV Guidelines", "Can. English Ratings" or "Can. French Ratings") from the Parental CTRL to reactivate BLOCK. (See pages 59 and 61.)

#### Method 3:

Switch off the TV power.

#### NOTE

- Performing any of the three above will activate the V-CHIP BLOCK.

# Other viewing options

## Viewing a list of channels

You can view a list of all currently available broadcast channels.

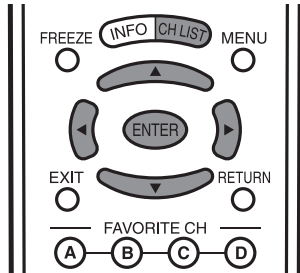

1

Press **CH LIST**.

- A list of all channels (Air or Cable) currently available will be displayed.

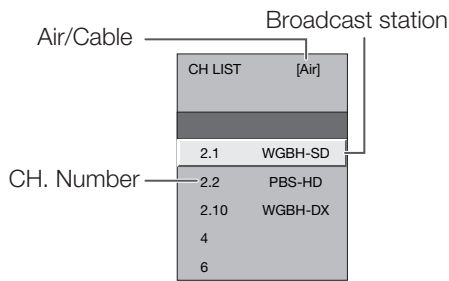

(Example)

Channel List Screen for Air Broadcasts

2

Press **▲/▼** to select the channel you want to watch, and then press **ENTER** to display the selected channel.

3

Press **◀/▶** to scroll between pages of the Channel List.

## Viewing information of the program

You can view information about a digital program you are currently watching.

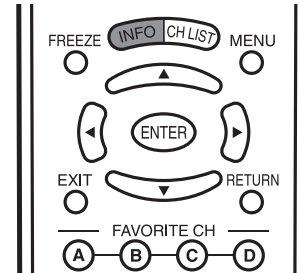

1

Press **INFO** while watching a digital broadcast.

- Information of the current program will be displayed.

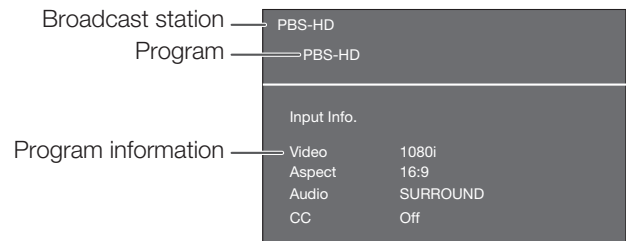

Sample program information

- If the program you are receiving is copy-protected, an icon will be displayed in the program information. Recording digital programs via i.LINK, or recording digital audio via digital audio output terminals, is restricted.

Icon	Description
	Digital copying prohibited
	One digital copy only

### NOTE

- Sometimes the name of the program is not broadcast. In that case, the program name will not be displayed.

## Other viewing options

### Freezing images

Allows you to capture and freeze a moving image that you are watching.

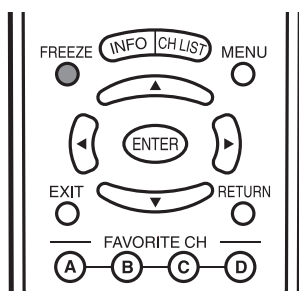

1

Press **FREEZE**.

- A moving image is captured.

2

Press **FREEZE** again to cancel the function.

#### NOTE

- When this function is not available, "No displaying still image available." will display.
- The still image automatically goes out after 30 minutes.
- If you are using the freeze function and a broadcast activates the V-CHIP BLOCK, the freeze function will be cancelled and a V-CHIP BLOCK message will appear.

### Presetting remote control function

You can operate the connected AV products (AV Receiver, Cable Box, SAT tuner, DTV, VCR, DVD, LD) using the presetting manufacturer function of your remote control unit.

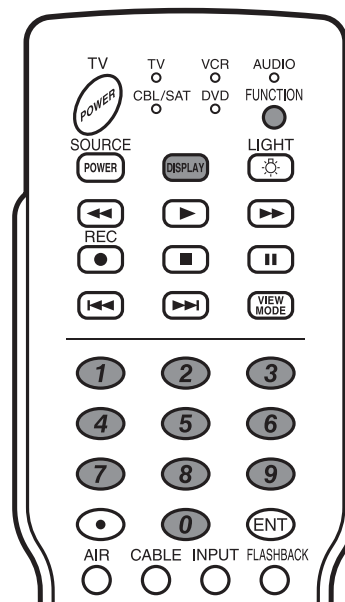

1

Press **FUNCTION** until the LED for your device lights up.

2

After the LED for your device lights up, press **FUNCTION** and **DISPLAY** at the same time to enter the code registration mode. The LED will blink.

3

Press **0-9** to enter the manufacturer code. (See page 64.)

- Preset mode is finished once the LED no longer lights up.

4

After registering the code, the LED will stop blinking then turn off after one second. (If you perform an incorrect operation, the LED will blink quickly then turn off.)



## Other viewing options

### Manufacturer codes

VCR BRAND	REMOTE CONTROL CODE NUMBER
Akai	25, 26, 37
Audio	15, 22, 30
Broksonic	32
Canon	04
Capehart	34
Craig	10, 31
Curtis Mathis	04
Daewoo	34
DBX	15, 22, 30
Dynatech	29
Emerson	21, 32, 35
Fisher	09, 10, 11
Funai	28, 29
G.E.	04
Goldstar	24
Hitachi	06, 47
Instant Replay	04
JC Penney	04, 06, 24, 30
JVC	15, 41, 42, 53
Kenwood	14, 15
Lloyds	29
Magnavox	04, 05, 08
Magnin	31
Marantz	30
Memorex	04, 10, 24, 29
Minolta	06
Mitsubishi	17, 18, 39, 40
Montgomery Ward	02, 43
Multitech	29
NEC	15, 22, 30
Panasonic	44, 45
Pentax	05, 06
Philco	05
Philips	05, 08
RCA	06, 07, 33, 51
Realistic	01, 02, 10, 24
Samsung	23, 31
Sanyo	10, 14, 52
Scott	20
Sears	06, 11, 24
Sharp	01, 02, 03
Shintom	36
Sony	12, 13, 38
Sound Design	29
Sylvania	05, 08
Symphonic	29
Tatung	15
Teac	15, 29
Teknika	27, 29
Thomas	29
TMK	21
Toshiba	19, 20
Video Concepts	30
Yamaha	15, 29, 30
Zenith	16

DVD/LD BRAND	REMOTE CONTROL CODE NUMBER
Denon	02
JVC	09, 13
Kenwood	21
Magnavox	04
Marantz	04
Mitsubishi	06
Panasonic	02, 22
Philips	04, 23
Pioneer	08, 11, 20
Proscan	03
RCA	03, 24
Samsung	07, 12
Sharp	01, 10
Sony	05, 25
Toshiba	04
Yamaha	02
Zenith	04

CATV/SAT BRAND	REMOTE CONTROL CODE NUMBER
Anvision	04, 05
Cable Star	04, 05
Eagle	05
General Instrument	02, 03, 07, 12, 13, 14, 19, 22
Jerrold	02, 03, 07, 12, 13, 14, 19, 22, 31, 32, 33, 34, 35, 36, 37, 38, 39, 40
Magnavox	04, 05, 09, 14, 17, 18, 20, 21, 24, 25
Oak Sigma	8
Panasonic	16, 23
Philips	04, 05, 09, 15, 17, 18, 20, 21, 24, 25
Pioneer	08, 10, 29, 30, 43*, 46
Randtek	04, 05
RCA	16, 27, 44*, 45*
Scientific Atlanta	01, 26
Sony	28
Viewstar	04, 05, 09, 15, 17, 18, 20, 21, 24, 25
Zenith	06, 14

#### NOTE

- Numbers marked with \* are SAT codes, all others are CATV codes.

AUDIO BRAND	REMOTE CONTROL CODE NUMBER
Sharp	01

## Other viewing options

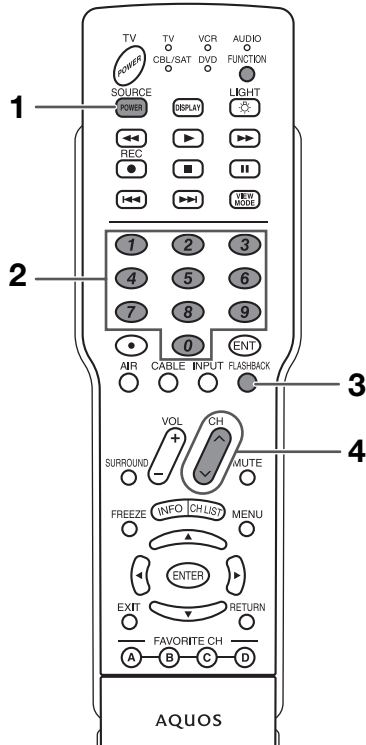

### Cable control buttons

When the **FUNCTION** is set to CBL/SAT, the cable converter connected to the TV can be operated using **1** to **4**.

#### 1 SOURCE POWER

Turns the cable converter power on and off.

#### 2 0-9

Press a button (or buttons) that corresponds to the channel that you wish to watch.

#### 3 FLASHBACK \*

Press to switch between the current channel and the channel you were watching immediately before.

#### 4 CH $\wedge$ / $\vee$

Press **CH  $\wedge$**  or **CH  $\vee$**  to tune in a higher or lower channel.

\* Some manufacturers do not preset **FLASHBACK**.

#### NOTE

- CABLE and SAT cannot be selected at the same time.

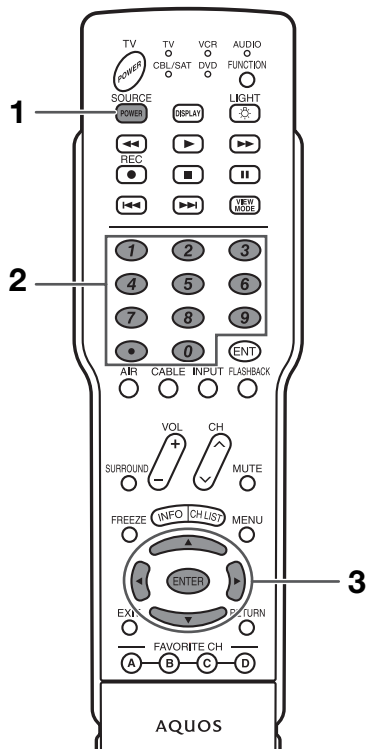

### SAT control buttons

#### 1 SOURCE POWER

Turns the cable converter power on and off.

#### 2 0-9, • (DOT)

Press a button (or buttons) that corresponds to the channel that you wish to watch.

#### 3 ENTER, $\blacktriangle$ / $\blacktriangledown$ / $\blacktriangleleft$ / $\blacktriangleright$

**ENTER:** Press to activate the selected function.

**$\blacktriangle$ / $\blacktriangledown$ / $\blacktriangleleft$ / $\blacktriangleright$ :** Press the button to select items on the SAT GUIDE screen or SAT MENU screen.

#### NOTE

- CABLE and SAT cannot be selected at the same time.

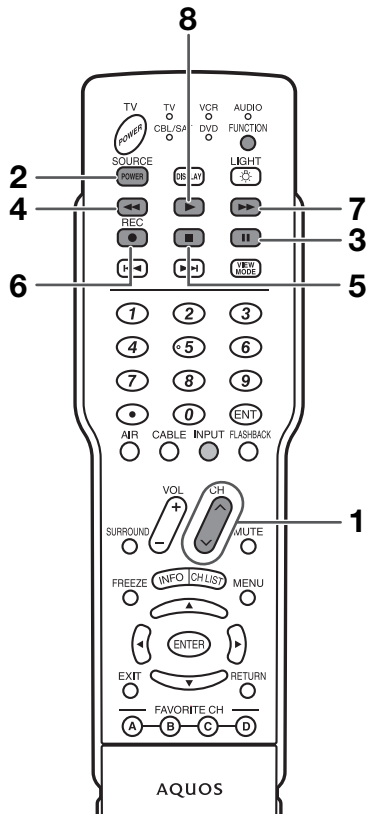

### VCR control buttons

The remote control unit button will function as follows when the **FUNCTION** of the remote control unit is set to VCR.

- Press **INPUT** until the input connected to the VCR is selected. The following **1 to 8** can be used to control the VCR.
- 1 CH  $\wedge/\vee$**   
Press to select the channel of the TV tuner on the VCR.
  - 2 SOURCE POWER**  
Turns the power of the VCR on and off.
  - 3 II**  
Sets pauses and still pictures.
  - 4  $\lll$**   
Rewinds the tape and allows picture search.
  - 5 ■**  
Stops the tape transport.
  - 6 REC**  
Starts recording.
  - 7  $\ggg$**   
Rapidly advances the tape and allows picture search.
  - 8  $\blacktriangleright$**   
Starts playback.

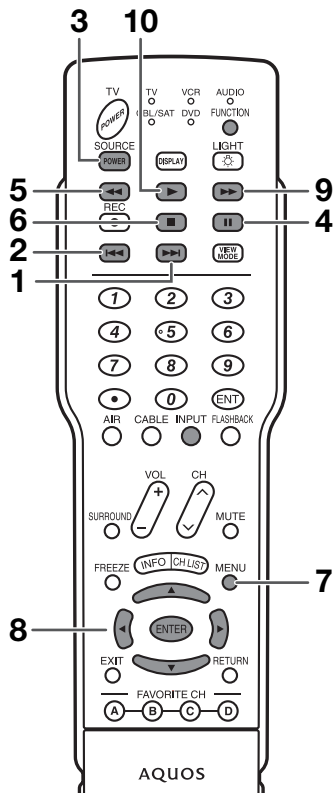

### DVD control buttons

The remote control unit button will function as follows when the **FUNCTION** of the remote control unit is set to DVD.

- Press **INPUT** until the input connected to the DVD player is selected. The following **1 to 10** can be used to control the DVD player.
- 1  $\ggg$**   
Pressing quickly once takes you to the start of the next chapter. Each time you press it, you move ahead to the start of the next chapter.
  - 2  $\lll$**   
Pressing quickly once takes you to the start of the chapter currently playing. Each time you press it, you move back to the start of the previous chapter.
  - 3 SOURCE POWER**  
Turns the power of the DVD player on and off.
  - 4 II**  
Sets pauses and still pictures.
  - 5  $\lll$**   
Hold down to go in reverse.
  - 6 ■**  
Playback stops when pressed.  
With some DVD players, pressing the button twice may open the disc tray.
  - 7 MENU**  
When this button is pressed, the DVD menu will display.
  - 8 ENTER,  $\blacktriangle/\blacktriangledown/\blacktriangleleft/\blacktriangleright$**   
**ENTER:** Press to activate the selected function.  
 $\blacktriangle/\blacktriangledown/\blacktriangleleft/\blacktriangleright$ : Press the button to select items on the DVD MENU screen.
  - 9  $\ggg$**   
Hold down to fast forward.
  - 10  $\blacktriangleright$**   
Starts playback.

# Appendix

## Removing the stand

Before detaching (or attaching) stand, unplug the AC cord from the AC INPUT terminal.

### CAUTION

- Do not remove the stand from the TV unless using an optional wall mount bracket to mount it.

### Before attaching/detaching stand

- Before performing work make sure to turn off the TV.
- Before performing work spread cushioning over the base area to lay the TV on. This will prevent it from being damaged.

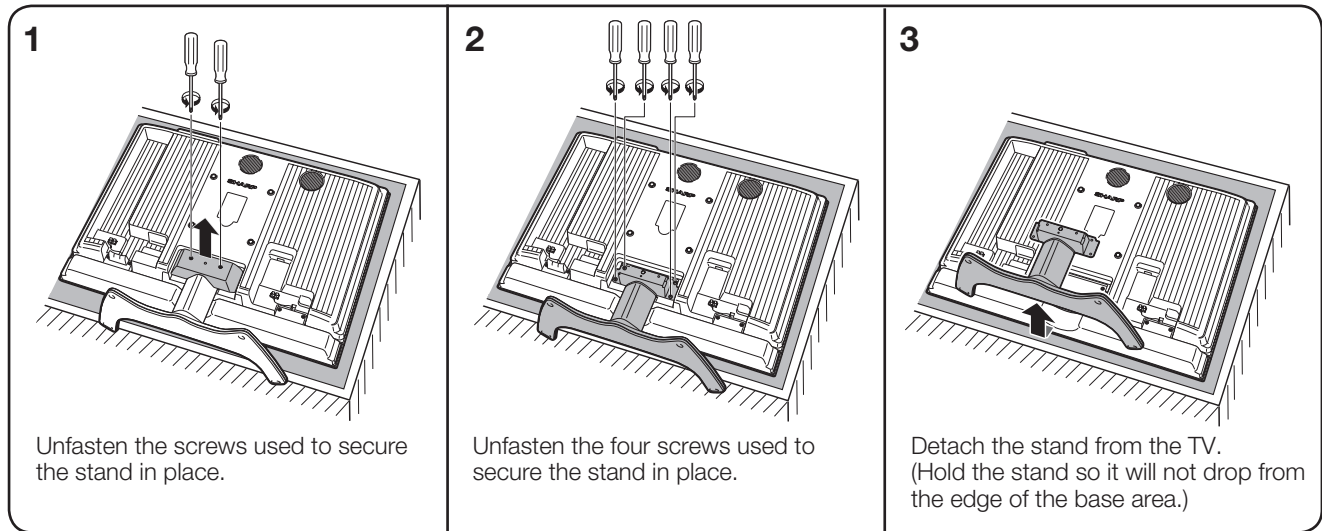

### NOTE

- To attach the stand, perform the above steps in reverse order.

## Setting the TV on the wall

### CAUTION

- Installing the TV requires special skill that should only be performed by qualified service personnel. Customers should not attempt to do the work themselves. SHARP bears no responsibility for improper mounting or mounting that results in accident or injury.

### Using an optional bracket to mount the TV

- You can ask a qualified service professional about using an optional AN-37AG2 bracket to mount the TV to the wall.
- Carefully read the instructions that come with the bracket before beginning work.

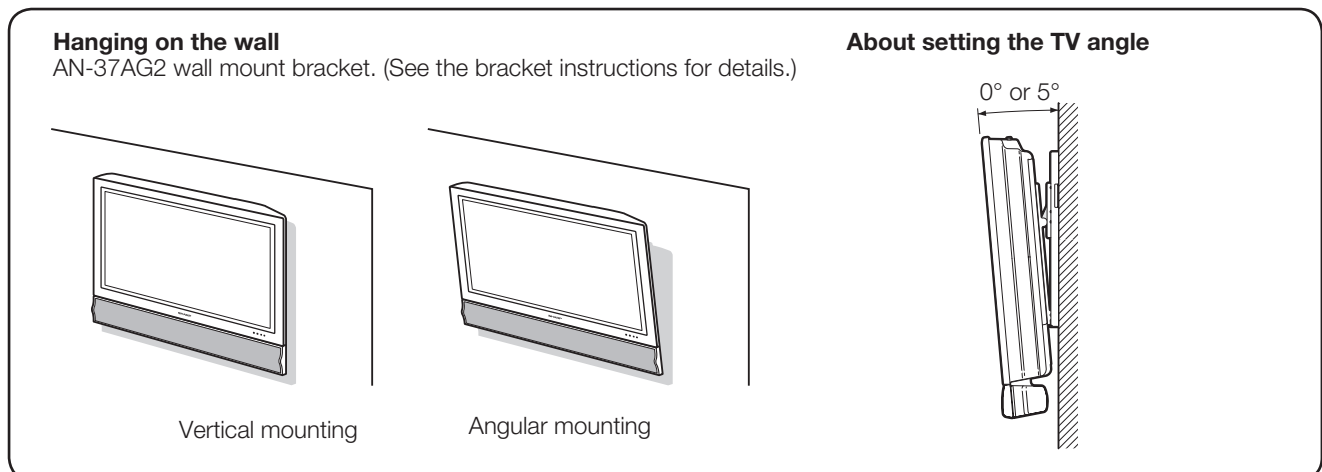

### NOTE

- Detach the cable clamp on the rear of the TV when using the optional mount bracket.

## Removing the speakers

1

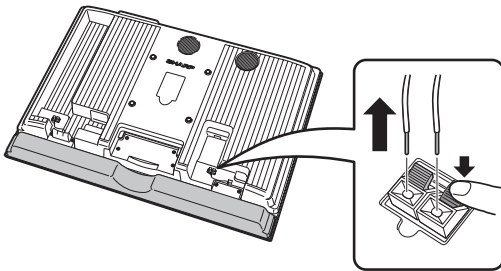

Disconnect the cable from the speakers.  
Perform the same steps for both sides.

2

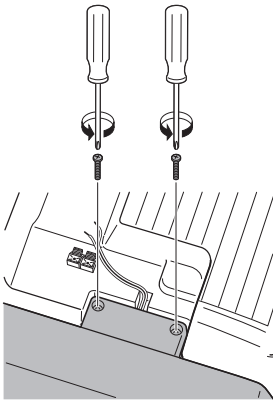

Unfasten the screws.  
Perform the same steps for both sides.

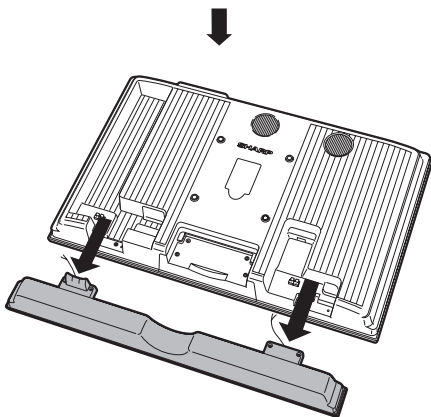

### CAUTION

- Do not remove the stand and speakers from the TV unless using an optional bracket to mount it.

### NOTE

- To attach the speakers, perform the steps in reverse order.

**Troubleshooting**

Problem	Possible Solution
<ul style="list-style-type: none"> <li>No power</li> </ul>	<ul style="list-style-type: none"> <li>Check if you pressed <b>TV POWER</b> on the remote control unit. (See page 14.) If the indicator on the TV does not light up, press <b>POWER</b> on the TV.</li> <li>Is the AC cord disconnected? (See page 7.)</li> <li>Has the power been turned on? (See page 14.)</li> </ul>
<ul style="list-style-type: none"> <li>Unit cannot be operated.</li> </ul>	<ul style="list-style-type: none"> <li>External influences such as lightning, static electricity, may cause improper operation. In this case, operate the unit after first turning on the power of the TV or unplugging the AC cord and replugging it in after 1 or 2 minutes.</li> </ul>
<ul style="list-style-type: none"> <li>Remote control unit does not operate.</li> </ul>	<ul style="list-style-type: none"> <li>Is the <b>FUNCTION</b> set correctly? Set it to the TV setting position.</li> <li>Are batteries inserted with polarity (+, -) aligned? (See page 8.)</li> <li>Are batteries worn out? (Replace with new batteries.)</li> <li>Are you using it under strong or fluorescent lighting?</li> <li>Is a fluorescent light illuminated near the remote control sensor?</li> </ul>
<ul style="list-style-type: none"> <li>Picture is cut off/with sidebar screen.</li> </ul>	<ul style="list-style-type: none"> <li>Is the image position correct? (See page 44.)</li> <li>Are screen mode adjustments such as picture size made correctly? (See pages 49 to 50.)</li> </ul>
<ul style="list-style-type: none"> <li>Strange color, light color, or color misalignment</li> </ul>	<ul style="list-style-type: none"> <li>Adjust the picture tone. (See pages 24 to 25.)</li> <li>Is the room too bright? The picture may look dark in a room that is too bright.</li> <li>Check the input signal setting. (See page 47.)</li> </ul>
<ul style="list-style-type: none"> <li>Power is suddenly turned off.</li> </ul>	<ul style="list-style-type: none"> <li>Is the sleep timer set? (See page 53.)</li> <li>Check the power control settings. (See page 27.)</li> <li>The unit's internal temperature has increased. Remove any objects blocking vent or clean.</li> </ul>
<ul style="list-style-type: none"> <li>No picture</li> </ul>	<ul style="list-style-type: none"> <li>Is connection to other components correct? (See pages 30 to 34.)</li> <li>Is correct input signal source selected after connection? (See page 47.)</li> <li>Is the correct input selected? (See page 47.)</li> <li>Is picture adjustment correct? (See pages 24 to 25.)</li> <li>Is "On" selected in "Audio Only"? (See page 52.)</li> <li>Is a non-compatible signal being input? (See page 70.)</li> </ul>
<ul style="list-style-type: none"> <li>No sound</li> </ul>	<ul style="list-style-type: none"> <li>Is the volume too low? (See page 17.)</li> <li>Is "Variable" selected in "Output Select"? (See page 52.)</li> </ul>

**Cautions regarding use in high and low temperature environments**

- When the unit is used in a low temperature space (e.g. room, office), the picture may leave trails or appear slightly delayed. This is not a malfunction, and the unit will recover when the temperature returns to normal.
  - Do not leave the unit in a hot or cold location. Also, do not leave the unit in a location exposed to direct sunlight or near a heater, as this may cause the cabinet to deform and the Liquid Crystal panel to malfunction.
- Storage temperature: -4°F to +140°F (-20°C to +60°C)

## Appendix

### Troubleshooting-Digital broadcasting

The error message about reception of broadcast

The example of an error message displayed on a screen	Error code	Possible Solution
<ul style="list-style-type: none"> <li>Failed to receive broadcast.</li> </ul>	<b>E202</b>	<ul style="list-style-type: none"> <li>Check the antenna cable. Check that the antenna is correctly setup.</li> </ul>
<ul style="list-style-type: none"> <li>No broadcast now.</li> </ul>	<b>E203</b>	<ul style="list-style-type: none"> <li>Check the broadcast time in the program guide.</li> </ul>

The cautions about i.LINK

Caution sentence	Possible Solution
<ul style="list-style-type: none"> <li>Record/Playback may fail on the selected model.</li> </ul>	<ul style="list-style-type: none"> <li>Displayed when you have selected a device that is not compatible with the TV, or that does not have DTLA copy protection technology installed.</li> </ul>
<ul style="list-style-type: none"> <li>Wrong connection or no i.LINK connection was found. Refer to Operation Manual on connection.</li> </ul>	<ul style="list-style-type: none"> <li>Displayed when a problem is experienced with a connection using i.LINK cable. Check the connection, and re-connect the cable if necessary.</li> </ul>
<ul style="list-style-type: none"> <li>The selected model is disabled to record/play. Check that no other model is used.</li> </ul>	<ul style="list-style-type: none"> <li>Displayed when the device you have selected is already being used by another i.LINK connected device. To operate the selected device from the TV, you will first have to override control from the other device.</li> </ul>

### PC compatibility chart

PC/MAC	Resolution	Horizontal Frequency	Vertical Frequency	VESA Standard	
PC	VGA	720 x 400	31.5 kHz	70 Hz	—
		640 x 480	31.5 kHz	60 Hz	○
			37.9 kHz	72 Hz	○
	37.5 kHz		75Hz	○	
	SVGA	800 x 600	35.1 kHz	56 Hz	○
			37.9 kHz	60 Hz	○
			48.1 kHz	72 Hz	○
			46.9kHz	75 Hz	○
			48.4 kHz	60 Hz	○
	XGA	1024 x 768	56.5 kHz	70 Hz	○
			60.0 kHz	75 Hz	○
			47.7kHz	60 Hz	○
WXGA	1360 x 768	47.7kHz	60 Hz	○	
SXGA	1280 x 1024	64.0 kHz	60 Hz	○	
UXGA*	1600 x 1200	75.0 kHz	60 Hz	○	
MAC13"	VGA	640 x 480	34.9 kHz	67 Hz	—
MAC16"	SVGA	832 x 624	49.7 kHz	75 Hz	—
MAC19"	XGA	1024 x 768	60.2 kHz	75 Hz	—

\*Digital input only.

Apple and Macintosh are registered trademarks of Apple Computer, Inc.  
 DDC is a registered trademark of Video Electronics Standards Association.  
 Power Management is a registered trademark of Sun Microsystems, Inc.  
 VGA and XGA are registered trademarks of International Business Machines Co., Inc.

## Appendix

### RS-232C port specifications

#### PC Control of the TV

- When a program is set, the TV can be controlled from the PC using the RS-232C terminal. The input signal (PC/AV) can be selected, the volume can be adjusted and various other adjustments and settings can be made, enabling automatic programmed playing.
- Attach an RS-232C cable cross-type (commercially available) to the supplied Din/D-Sub RS-232C for the connections.

#### NOTE

- This operation system should be used by a person who is accustomed to using computers.

#### Communication conditions

Set the RS-232C communication settings on the PC to match the TV's communication conditions. The TV's communication settings are as follows:

<b>Baud rate:</b>	9,600 bps
<b>Data length:</b>	8 bits
<b>Parity bit:</b>	None
<b>Stop bit:</b>	1 bit
<b>Flow control:</b>	None

#### Communication procedure

Send the control commands from the PC via the RS-232C connector.

The TV operates according to the received command and sends a response message to the PC.

Do not send multiple commands at the same time. Wait until the PC receives the OK response before sending the next command.

#### Command format

Eight ASCII codes + CR

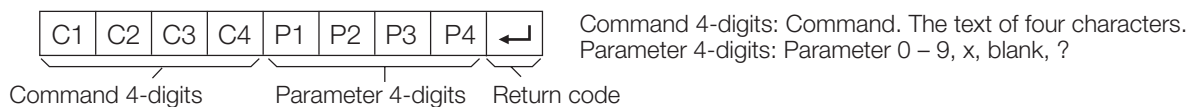

#### Parameter

Input the parameter values, aligning left, and fill with blank(s) for the remainder. (Be sure that 4 values are input for the parameter.)

When the input parameter is not within an adjustable range, "ERR" returns. (Refer to "Response code format".) Any numerical value can replace the "x" on the table.

0			
0	0	0	9
-	3	0	
1	0	0	
0	0	5	5

When "?" is input for some commands, the present setting value responds.

?			
?	?	?	?



# Appendix

## Response code format

Normal response

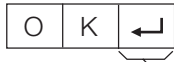

Return code (ODH)

Problem response (communication error or incorrect command)



Return code (ODH)

## Command table

- Commands not indicated here are not guaranteed to operate.

CONTROL ITEM	COMMAND	PARAMETER	CONTROL CONTENTS		
POWER SETTING	P O W E R	0 _ _ _	Power Off	It shifts to standby.	
		1 _ _ _	Power On	Effective only when the Standby Mode is set to "Mode1".	
INPUT SELECTION A	I T G D	x _ _ _	(Toggle)	It input-switches by the toggle. (It is the same as an input change key)	
		I T V D	x _ _ _	It input-switches to TV. (A channel remains as it is. (Last memory))	
		I A V D	* _ _ _	Input terminal number (1-5)	It input-switches to INPUT1-INPUT5.
INPUT SELECTION B	I N P 1	L I N K	x _ _ _	It input-switches to i.LINK.	
		I N P 1	0 _ _ _	AUTO	An input change is also included.
			1 _ _ _	VIDEO	
			2 _ _ _	COMPONENT	
			5 _ _ _	DIGITAL	
I N P 5	6 _ _ _	ANALOG			
AV MODE SELECTION	A V M D	0 _ _ _	(Toggle)	Although it can choose now, it is toggle operation in inside.	
		1 _ _ _	STANDARD		
		2 _ _ _	MOVIE		
		3 _ _ _	GAME		
		4 _ _ _	USER		
		5 _ _ _	DYNAMIC (Fixed)		
		6 _ _ _	DYNAMIC		
		7 _ _ _	PC		
VOLUME	V O L M	* * _ _	Volume (0-60)		
POSITION	H P O S	* * * _	AV mode. (± 10)		
		* * * _	PC mode. (0-180)		
	V P O S	* * * _	AV mode. (± 20)		
		* * * _	PC mode. (0-100)		
CLOCK	C L C K	* * * _	Only PC mode. (0-180)	Only available when DVI ANALOG is being input.	
		* * * _	Only PC mode. (0-40)	Only available when DVI ANALOG is being input.	
VIEWMODE	W I D E	0 _ _ _	(Toggle) [AV]	Although it can choose now, it is toggle operation in inside.	
		1 _ _ _	Side Bar [AV]		
		2 _ _ _	S.Stretch [AV]		
		3 _ _ _	Zoom [AV]		
		4 _ _ _	Stretch [AV]		
		5 _ _ _	Normal [PC]		
		6 _ _ _	Zoom [PC]		
		7 _ _ _	Stretch [PC]		
		8 _ _ _	Dot by Dot [AV] [PC]		
		9 _ _ _	Full Screen [AV]		
MUTE	M U T E	0 _ _ _	(Toggle)		
		1 _ _ _	On		
		2 _ _ _	Off		
Surround	A C S U	0 _ _ _	(Toggle)		
		1 _ _ _	On		
		2 _ _ _	Off		
AUDIO SELECTION	A C H A	x _ _ _	(Toggle)		
SLEEP TIMER	O F T M	0 _ _ _	OFF		
		1 _ _ _	OFF TIMER - 30 MIN.		
		2 _ _ _	OFF TIMER - 60 MIN.		
		3 _ _ _	OFF TIMER - 90 MIN.		
		4 _ _ _	OFF TIMER - 120 MIN.		
CHANNEL	D I R E C T	C H A N N E L (ANALOG)	* * * * _	The channel number of TV (1-135) An input change is included if it is not TV display. In Air, 2-69ch is effective.	
		D I R E C T	C H 2 P	* * * * _	(0101-9999) DIGITAL Air (Two-Part numbers, 2-digit plus 2-digit)
			C H 2 U	* * * * _	(0-999) DIGITAL Cable (Two-Part numbers, 3-digit plus 3-digit) Front half of DIGITAL CABLE CHANNEL NO. (Designate major channel)
			C H 2 L	* * * * _	(0-999) DIGITAL Cable (Two-Part numbers, 3-digit plus 3-digit) Rear half of DIGITAL CABLE CHANNEL NO. (Designate minor channel)
			C H 1 0	* * * * _	(0-9999) DIGITAL Cable (One-Part numbers, 5-digit, less than 10,000)
		C H 1 1	* * * * _	(0-6383) DIGITAL Cable (One-Part numbers, 5-digit, more than 10,000)	
		CH UP	C H U P	x _ _ _	The channel number of TV +1 If it is not TV display, it will input-switch to TV. (same function as CH▲)
CH DOWN	C H D W	x _ _ _	The channel number of TV -1 If it is not TV display, it will input-switch to TV. (same function as CH▼)		
Air/Cable SELECT	A C S L	0 _ _ _	(Toggle)	AIR → CABLE → AIR	
		1 _ _ _	AIR		
		2 _ _ _	CABLE		
CC	C L C P	x _ _ _	(Toggle)	Toggle operation of a closed caption.	

### NOTE

- If an underbar ( ) appears in the parameter column, enter a space.
- If an asterisk (\*) appears, enter a value in the range indicated in brackets under CONTROL CONTENTS.
- As long as that from which the parameter (x) in the table is a numerical value, it may write anything.

## Appendix

### Specifications

Item		Model: LC-37D90U	
LCD panel		37" Advanced Super View & BLACK TFT LCD	
Number of dots		6,220,800 dots (1920 × 1080 × 3 dots)	
TV Function	TV-standard	American TV Standard ATSC/NTSC System	
	Receiving Channel	VHF/UHF	VHF 2-13ch, UHF 14-69ch
		CATV	1-135ch (non-scrambled channel only)
		Digital Terrestrial Broadcast (8VSB)	2-69ch
		Digital cable* (64/256 QAM)	1-135ch (non-scrambled channel only)
Audio multiplex	BTSC System		
Backlight		60,000 hours (at Backlight Standard position)	
Audio out		10W × 2	
Terminals	Rear	INPUT 1	AV in, COMPONENT in
		INPUT 2	AV in, S-VIDEO in
		INPUT 3	HDMI in with HDCP
		INPUT 4	Audio in, HDMI in with HDCP
		INPUT 5	Audio in, DVI-I in with HDCP
		Air ANTENNA	75 Ω Unbalance, F Type for VHF/UHF/Digital Air in × 1
		Cable ANTENNA	75 Ω Unbalance, F Type for CATV/Digital Cable in × 1
		i.LINK	IEEE1394 × 2 with DTCP (Compatible with DTVLink)
		DIGITAL AUDIO OUTPUT	Optical Digital audio output × 1 (PCM/Dolby Digital)
		OUTPUT	Audio out
OSD language		English/French/Spanish	
Power Requirement		AC 120 V, 60 Hz	
Power Consumption		230 W	
Weight	w/o stand	50.7 lbs./23.0 kg	
	with stand	62.9 lbs./28.5 kg	
Dimension (W × H × D)	w/o stand	36 <sup>5</sup> / <sub>8</sub> × 26 <sup>9</sup> / <sub>64</sub> × 4 <sup>13</sup> / <sub>16</sub> inch	
	with stand	36 <sup>5</sup> / <sub>8</sub> × 28 <sup>45</sup> / <sub>64</sub> × 12 <sup>1</sup> / <sub>16</sub> inch	
Accessories		Remote control unit (× 1), AC cord (× 1), "AAA" size battery (× 2), Cable clamp (× 1), Cable tie (× 1), Operation manual (× 1)	
Operating temperature		+32°F to +104°F (0°C to +40°C)	

\* Emergency alert messages via Cable are unreceivable.

- As part of policy of continuous improvement, SHARP reserves the right to make design and specification changes for product improvement without prior notice. The performance specification figures indicated are nominal values of production units. There may be some deviations from these values in individual units.

### Optional accessory

The listed optional accessory is available for the Liquid Crystal Television. Please purchase it at your nearest shop.

- Additional optional accessories may be available in the near future. When purchasing, please read the newest catalogue for compatibility and check the availability.

Part name	Part number
Wall mount bracket	AN-37AG2

# Dimensional drawings

Unit: inch/(mm)

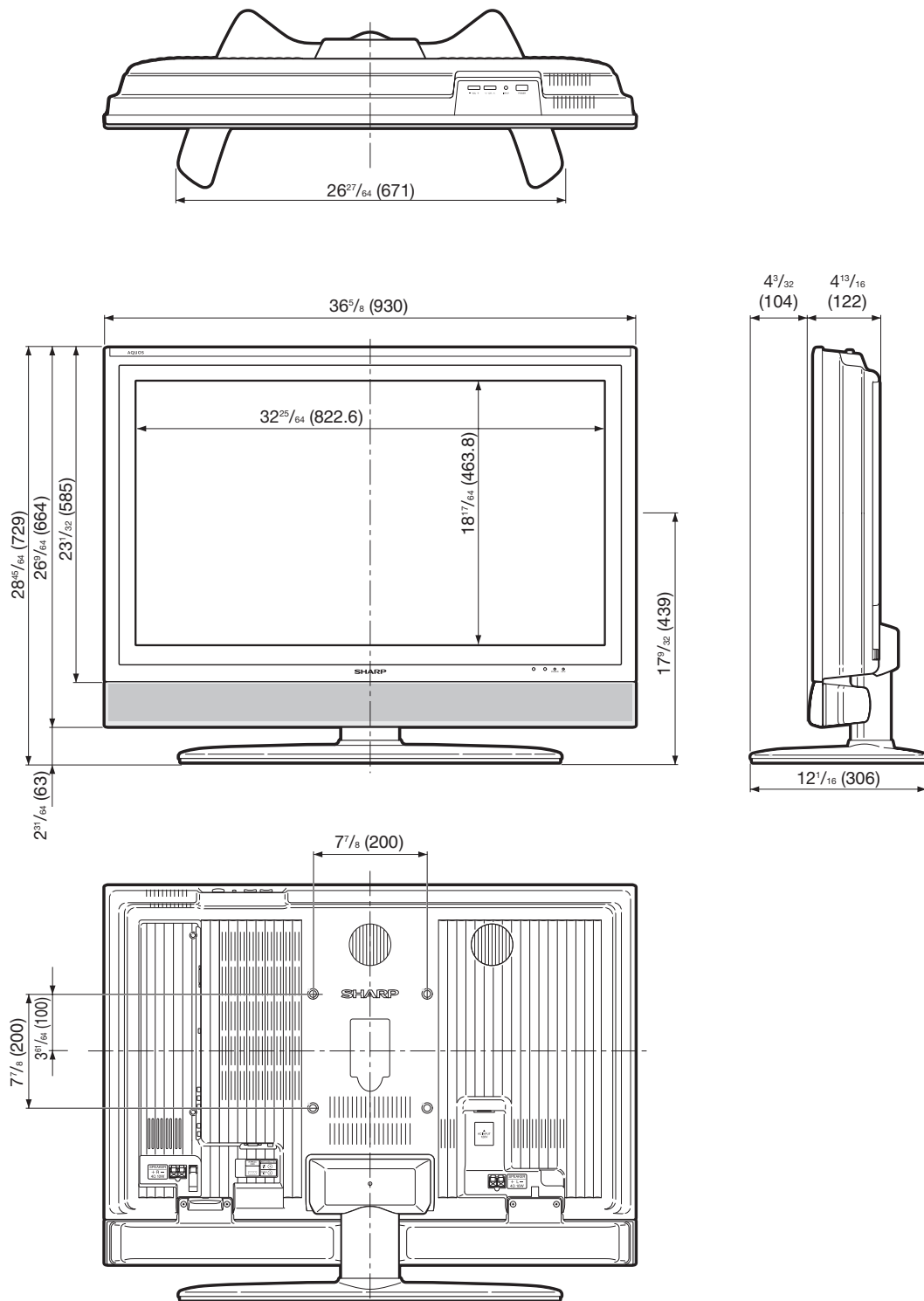

## CLEARING THE SECRET NUMBER

If you forget the secret number, clear the secret number using the following procedure.

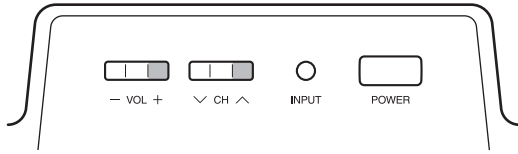

**1** Press **MENU** and the MENU screen displays.

**2** Press **◀▶** to select "Setup".

**3** Press **▲/▼** to select "EZ Setup", "CH Setup", "Parental CTRL" or "Reset", and the Secret number input screen displays.

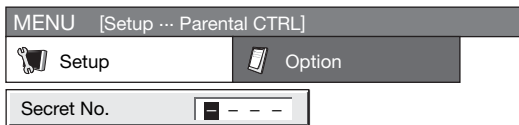

**4** Press and hold both **CH^** and **VOL+** on the TV simultaneously until the message appears on the screen.

The secret number is

--	--	--	--

.

### NOTE

- As a precautionary measure, make a note of your secret number above, cut it from this manual, and keep it in a safe place.

# Calling for Service

For location of the nearest Sharp Authorized Service, or to obtain product literature, accessories, supplies, or customer assistance, please call 1-800-BE-SHARP.

## LIMITED WARRANTY

### CONSUMER LIMITED WARRANTY

SHARP ELECTRONICS CORPORATION warrants to the first consumer purchaser that this Sharp brand product (the "Product"), when shipped in its original container, will be free from defective workmanship and materials, and agrees that it will, at its option, either repair the defect or replace the defective Product or part thereof with a new or remanufactured equivalent at no charge to the purchaser for parts or labor for the period(s) set forth below.

This warranty does not apply to any appearance items of the Product nor to the additional excluded item(s) set forth below nor to any Product the exterior of which has been damaged or defaced, which has been subjected to improper voltage or other misuse, abnormal service or handling, or which has been altered or modified in design or construction.

In order to enforce the rights under this limited warranty, the purchaser should follow the steps set forth below and provide proof of purchase to the servicer.

The limited warranty described herein is in addition to whatever implied warranties may be granted to purchasers by law. ALL IMPLIED WARRANTIES INCLUDING THE WARRANTIES OF MERCHANTABILITY AND FITNESS FOR USE ARE LIMITED TO THE PERIOD(S) FROM THE DATE OF PURCHASE SET FORTH BELOW. Some states do not allow limitations on how long an implied warranty lasts, so the above limitation may not apply to you.

Neither the sales personnel of the seller nor any other person is authorized to make any warranties other than those described herein, or to extend the duration of any warranties beyond the time period described herein on behalf of Sharp.

The warranties described herein shall be the sole and exclusive warranties granted by Sharp and shall be the sole and exclusive remedy available to the purchaser. Correction of defects, in the manner and for the period of time described herein, shall constitute complete fulfillment of all liabilities and responsibilities of Sharp to the purchaser with respect to the Product, and shall constitute full satisfaction of all claims, whether based on contract, negligence, strict liability or otherwise. In no event shall Sharp be liable, or in any way responsible, for any damages or defects in the Product which were caused by repairs or attempted repairs performed by anyone other than an authorized servicer. Nor shall Sharp be liable or in any way responsible for any incidental or consequential economic or property damage. Some states do not allow the exclusion of incidental or consequential damages, so the above exclusion may not apply to you.

THIS WARRANTY GIVES YOU SPECIFIC LEGAL RIGHTS. YOU MAY ALSO HAVE OTHER RIGHTS WHICH VARY FROM STATE TO STATE.

### Model Specific Section

**Your Product Model Number & Description:**

LC-37D90U LCD Color Television  
(Be sure to have this information available when you need service for your Product.)

**Warranty Period for this Product:**

One (1) year parts and labor from the date of purchase.

**Additional Item(s) Excluded from Warranty Coverage (if any):**

Non-rechargeable batteries.

**Where to Obtain Service:**

From a Sharp Authorized Servicer located in the United States. To find the location of the nearest Sharp Authorized Servicer, call Sharp toll free at 1-800-BE-SHARP.

**What to do to Obtain Service:**

Contact your Sharp Authorized Servicer to obtain in-home service for this Product. The Servicer will come to your home and if it is necessary to remove the Product, the Servicer will reinstall it. Be sure to have **Proof of Purchase** available.

TO OBTAIN PRODUCT INFORMATION, CALL 1-800-BE-SHARP OR VISIT [www.sharpusa.com](http://www.sharpusa.com)

# SHARP®

SHARP ELECTRONICS CORPORATION

Sharp Plaza, Mahwah, New Jersey 07430-2135

SHARP CORPORATION



**LIMITED WARRANTY**

*Consumer Electronics Products*

**Congratulations on your purchase!**

Sharp Electronics of Canada Ltd. (hereinafter called "Sharp") gives the following express warranty to the first consumer purchaser for this Sharp brand product, when shipped in its original container and sold or distributed in Canada by Sharp or by an Authorized Sharp Dealer:

Sharp warrants that this product is free, under normal use and maintenance, from any defects in material and workmanship. If any such defects should be found in this product within the applicable warranty period, Sharp shall, at its option, repair or replace the product as specified herein.

This warranty shall not apply to:

- (a) Any defects caused or repairs required as a result of abusive operation, negligence, accident, improper installation or inappropriate use as outlined in the owner's manual.
- (b) Any Sharp product tampered with, modified, adjusted or repaired by any party other than Sharp, Sharp's Authorized Service Centres or Sharp's Authorized Servicing Dealers.
- (c) Damage caused or repairs required as a result of the use with items not specified or approved by Sharp, including but not limited to head cleaning tapes and chemical cleaning agents.
- (d) Any replacement of accessories, glassware, consumable or peripheral items required through normal use of the product including but not limited to earphones, remote controls, AC adapters, batteries, temperature probe, stylus, trays, filters, belts, ribbons, cables and paper.
- (e) Any cosmetic damage to the surface or exterior that has been defaced or caused by normal wear and tear.
- (f) Any damage caused by external or environmental conditions, including but not limited to transmission line/power line voltage or liquid spillage.
- (g) Any product received without appropriate model, serial number and CSA/cUL markings.
- (h) Any products used for rental or commercial purposes.
- (i) Any installation, setup and/or programming charges.

Should this Sharp product fail to operate during the warranty period, warranty service may be obtained upon delivery of the Sharp product together with proof of purchase and a copy of this LIMITED WARRANTY statement to an Authorized Sharp Service Centre or an Authorized Sharp Servicing Dealer. In home warranty service may be provided at Sharp's discretion on any Sharp television with the screen size of 27" or larger and on any Sharp Over-the-Range Microwave Oven.

This warranty constitutes the entire express warranty granted by Sharp and no other dealer, service centre or their agent or employee is authorized to extend, enlarge or transfer this warranty on behalf of Sharp. To the extent the law permits, Sharp disclaims any and all liability for direct or indirect damages or losses or for any incidental, special or consequential damages or loss of profits resulting from a defect in material or workmanship relating to the product, including damages for the loss of time or use of this Sharp product or the loss of information. The purchaser will be responsible for any removal, reinstallation, transportation and insurance costs incurred. Correction of defects, in the manner and period of time described herein, constitute complete fulfillment of all obligations and responsibilities of Sharp to the purchaser with respect to the product and shall constitute full satisfaction of all claims, whether based on contract, negligence, strict liability or otherwise.

**WARRANTY PERIODS:**

	Parts & Labour (exceptions noted)
Audio Products	1 year
Camcorder	1 year
DVD Products	1 year
Projector	1 year (lamp 90 days)
LCD & Plasma Display TV	1 year
Microwave Oven	1 year (magnetron component-4 additional years)
Television Products	1 year (picture tube component-1 additional year)
VCR Products	1 year
Vacuum Cleaner	1 year

To obtain the name and address of the nearest Authorized Sharp Service Centre or Dealer, please contact:  
SHARP ELECTRONICS OF CANADA LTD. 335 Britannia Road East, Mississauga, Ontario L4Z 1W9

For more information on this Warranty, Sharp Extended Warranty Offers, Sharp Canada Products, Accessory Sales, Dealer or Service Locations, please call (905) 568-7140  
Visit our Web site: [www.sharp.ca](http://www.sharp.ca)



**SHARP®**

**SHARP ELECTRONICS CORPORATION**

Sharp Plaza, Mahwah, New Jersey 07430-2135

**SHARP CORPORATION**

Printed in Mexico  
Imprimé au Mexique  
Impreso en México  
TINS-C310WJZZ   
06P05-MX-NG